

Primary Usage  
Reference No.  
Sign. and date  
Copy inv. No.  
Repl. Inv. No.  
Sign. and date  
Orig. Inv. No.

4" Plastic Channel

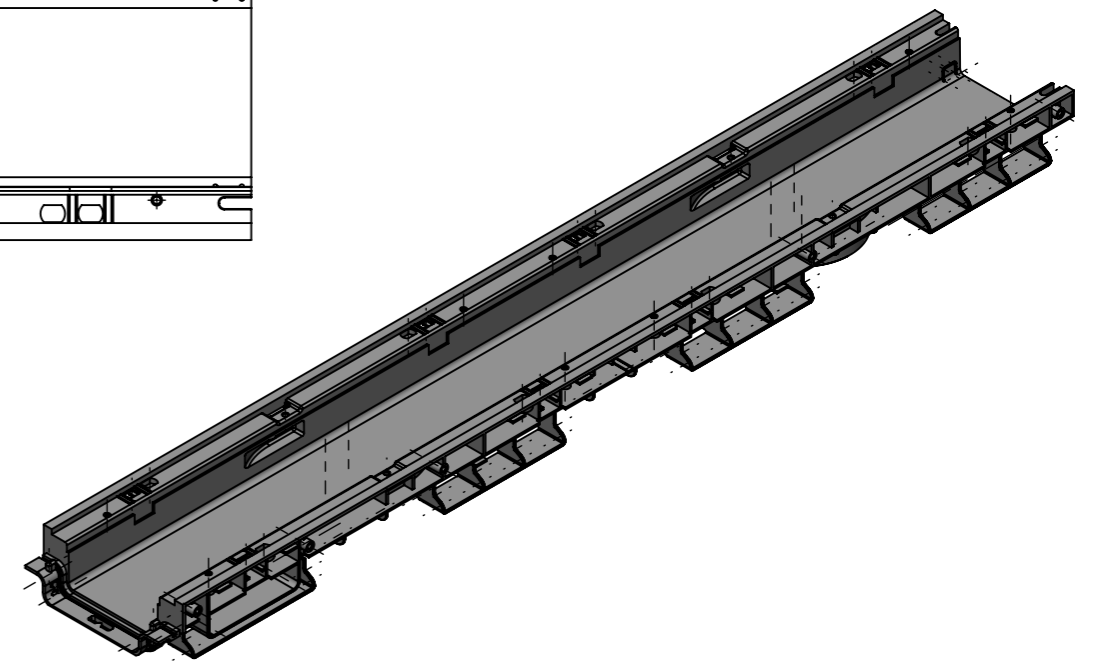
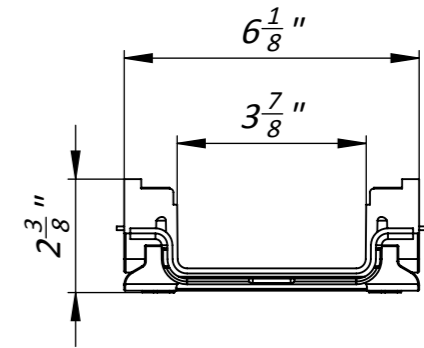
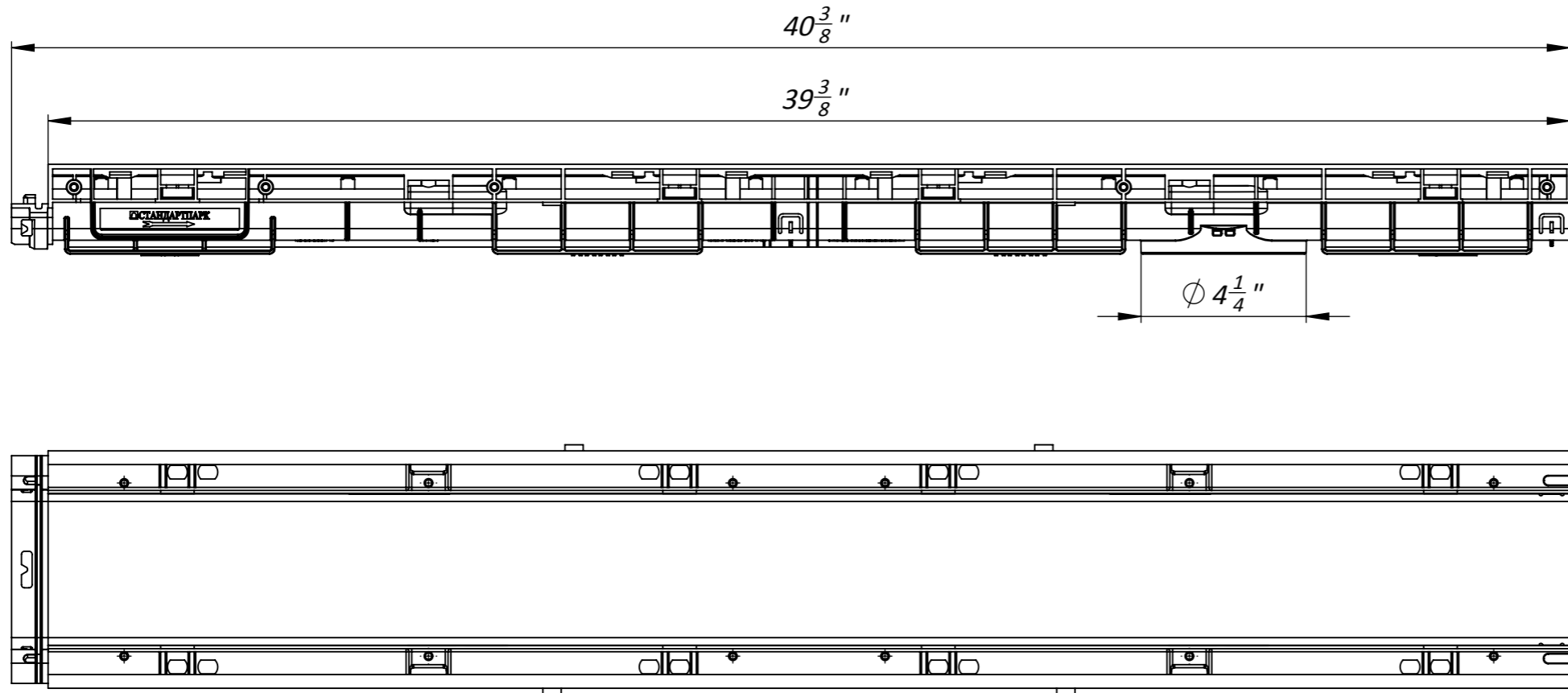

Deviation of the actual weight of the nominal can be up to 10%

					Art. 8050-M			
					4" Plastic Channel			
Rev.	Sheet	Doc. No.	Sign.	Data	<b>8050-M</b>	Let.	Weight (lb)	Scale
				11.09.18			2.04	1:4
					Load Class C	Sheet	Sheets 1	
					Plastic	