

# Barron

6812

INSTRUCTION MANUAL

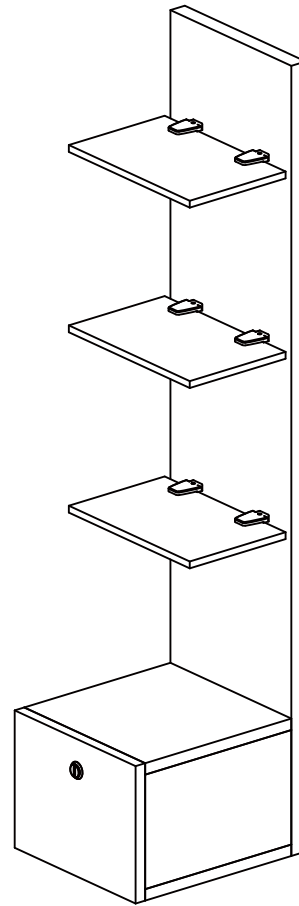

EN

## CONTENTS

Product Introduction	3
Warranty	4
Assembly Instructions	5
List of parts	5
Tools Necessary	7
Assembly Techniques Display	8
Instructions	9
Aftercare instructions	15
Contact Us	16

Please read the operation manual before using the product.

Please put the operation manual in the place easy for you to read and you can read it at any time.

Product Name: Barron

Product Code: 6812

DIR stylish display shelf Barron (DIR code: 6812) is the wall mounted unit offers even more space to promote products on the timbered glass shelf. The classic design will add the practicality and elegance to any salon.

# WARRANTY

The warranty period is one year. DIR warrants to you, the original buyer, that goods shall be free of defects in material and/or workmanship attributable to manufacture for one year from date of buyer's receipt of product. Damage resulting from improper handling after merchandise is received, or from exposure to weather or extreme atmospheric conditions is not covered by the warranty.

For any other information please contact our support team:

DIR BIRMINGHAM	DIR LONDON	DIR NEW YORK	DIR COLOGNE	DIR IRELAND
66 Rea Street South Birmingham B5 6LR UK ----- Tel: +44(0)121 6433877 ----- Email: sales@dirgroup.co.uk	Unit 1 River Road Business Park 33 River Road, Barking Greater London IG11 0DA UK ----- Tel: +44(0)20 8591 9310 ----- Email: sales.london@dirgroup.co.uk	24 Woodward Ave. Suite C Queens, NY 11385 USA ----- Tel: +1 (718)628-6668 +1 (800)728-2008 ----- Email: sales@dirsalonfurniture.com	Konrad-Adenauer-Straße 25 50996 Köln Germany ----- Tel: + 49 (0) 221/88888.128 ----- Email: sales@dirgroup.de	Unit 5 Block E, Riverview Business Park, Nangor Road, Dublin 12 Republic of Ireland ----- Tel: +353 (01) 429 7969 ----- Email: sales.ireland@dirgroup.ie

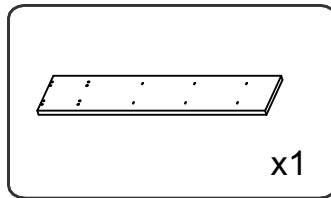

①

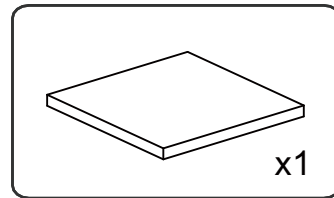

②

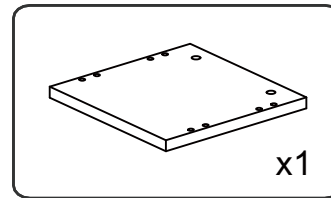

③

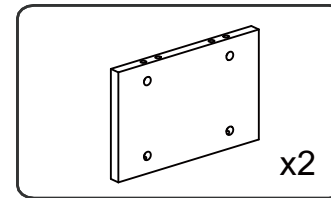

④

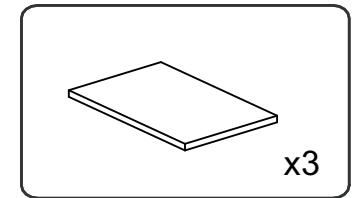

⑤

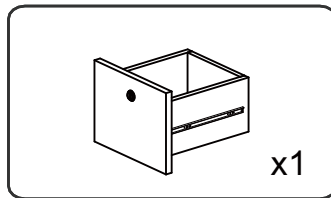

Drawer

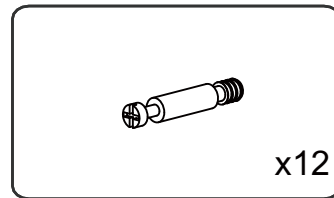

Ⓟ1 Ø6X32mm

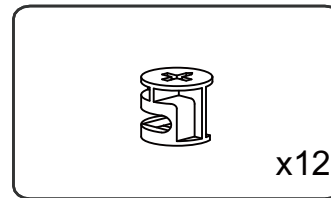

Ⓟ2 Ø15X12mm

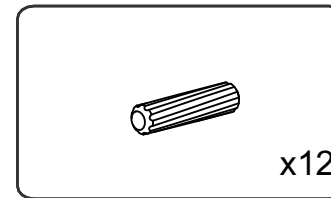

Ⓟ3 Ø8X40mm

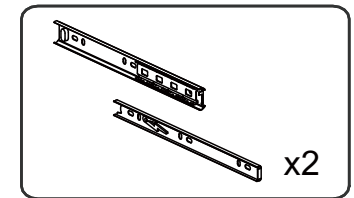

Ⓟ4 Drawer runner(A/B)

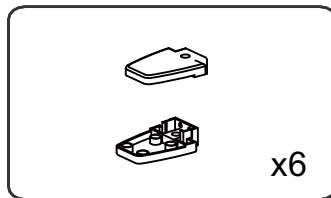

Ⓟ5 Glass Glamp

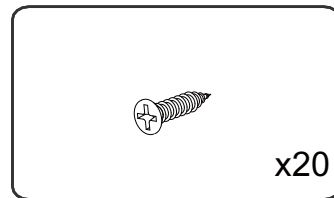

Ⓟ6 Tapping Screw

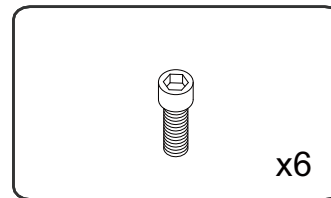

Ⓟ7 Screw

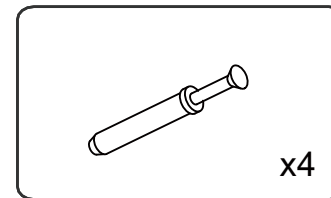

Ⓟ8 Expansion bolts

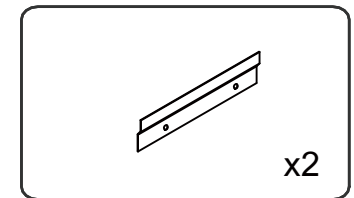

Ⓟ9 Hanger

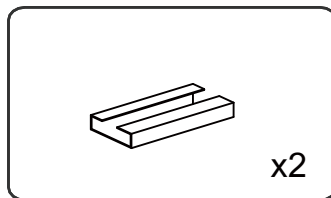

Ⓟ10 Groove



# ASSEMBLY INSTRUCTIONS

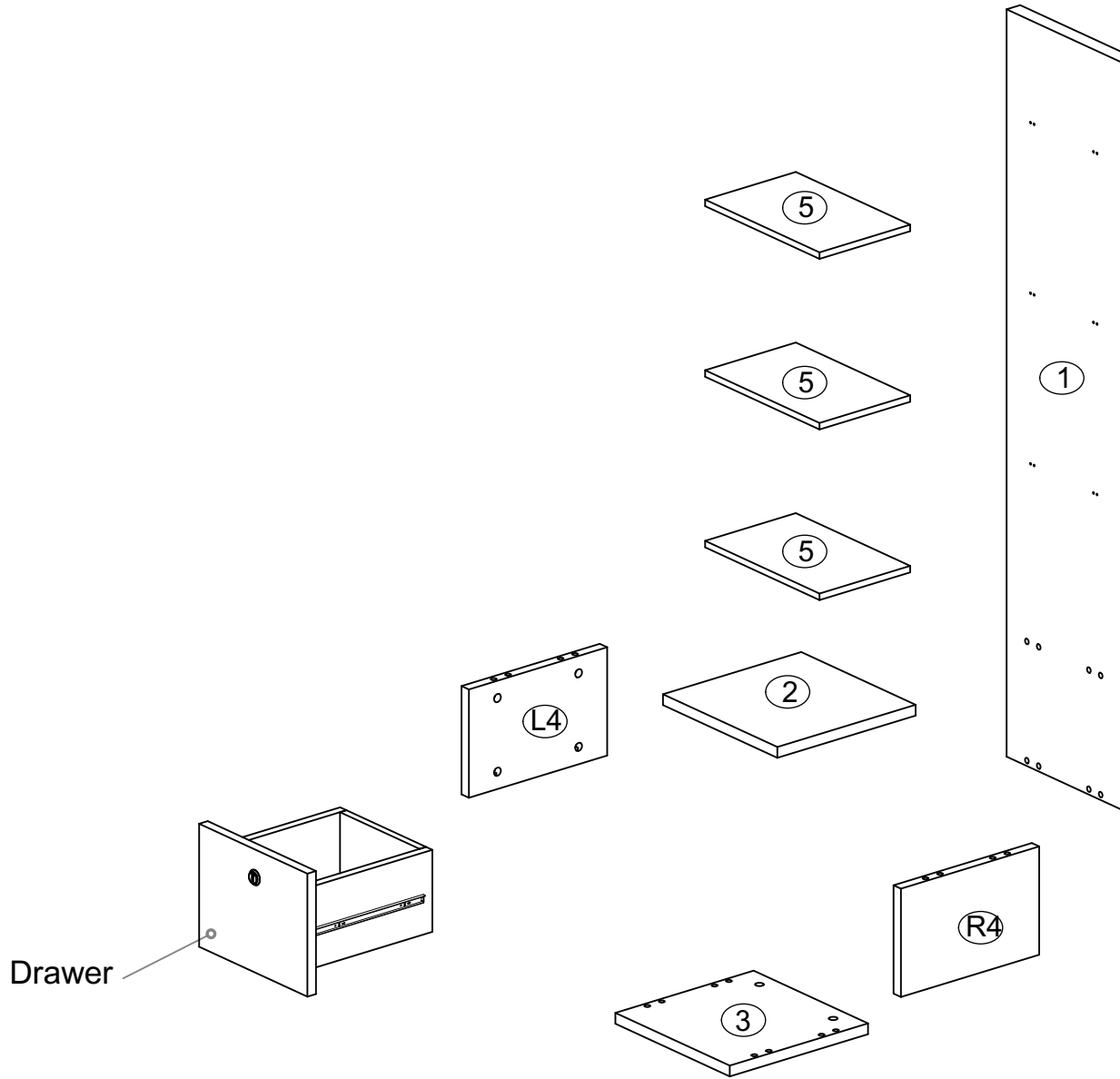

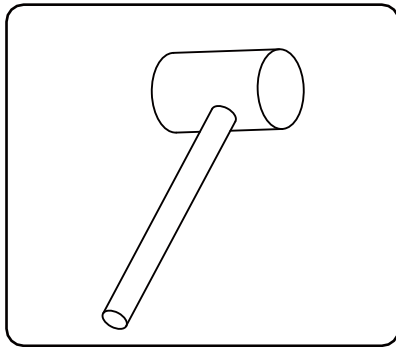

Rubber Hammer

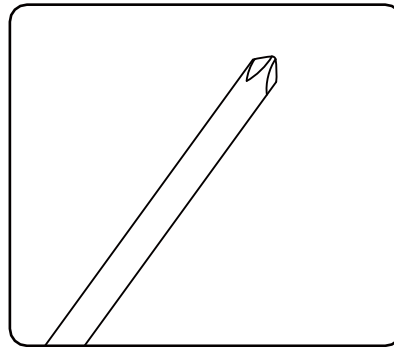

Cross screwdriver

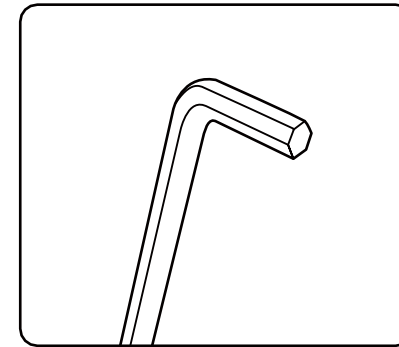

Allen Key

# ASSEMBLY INSTRUCTIONS

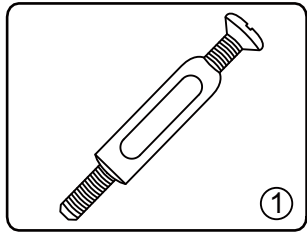

Ø6x32mm(x14)

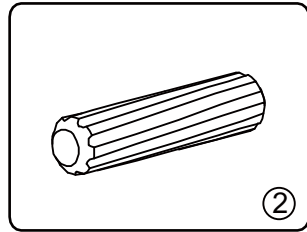

Ø8x40mm(x18)

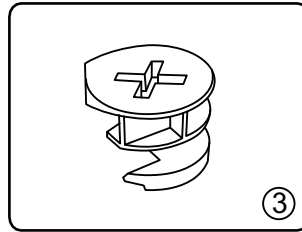

Ø15x12mm(x14)

## Assembly Techniques Display

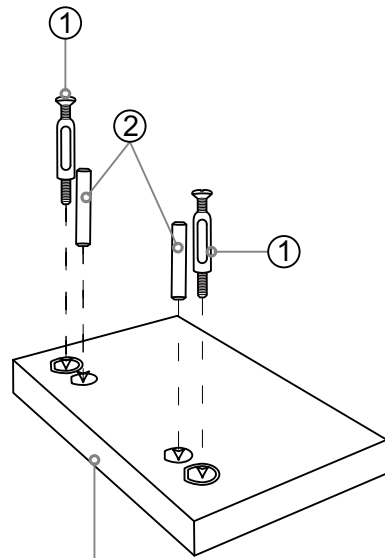

Wooden part A

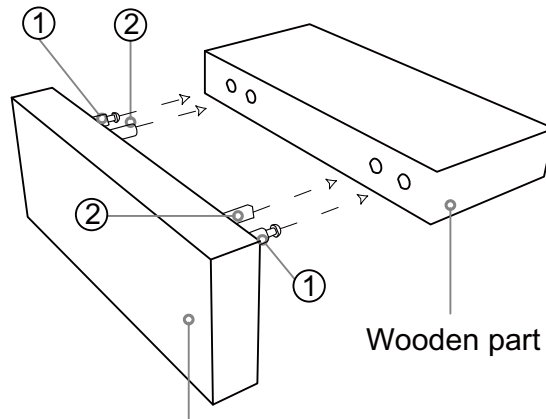

Wooden part A

Wooden part B

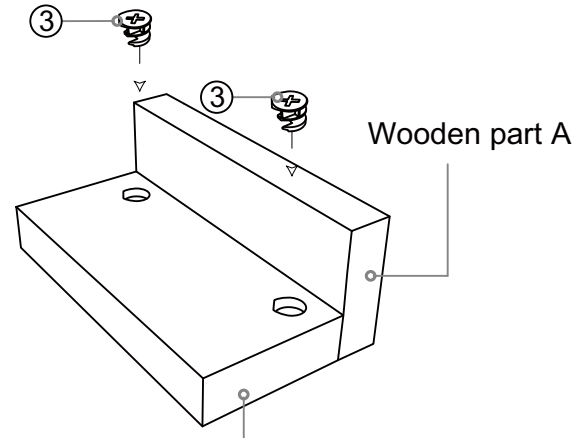

Wooden part B

Wooden part A



Please put parts together with full 3 techniques instructions for every assembly step in the following pages.



## ASSEMBLY INSTRUCTIONS

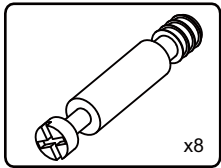

(P1) Ø6X32mm

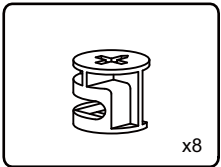

(P2) Ø15X12mm

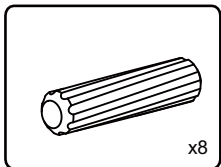

(P3) Ø8X40mm

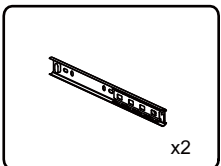

(P4) Drawer runner A

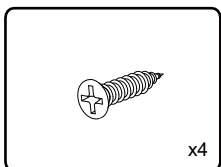

(P6) Tapping Screw

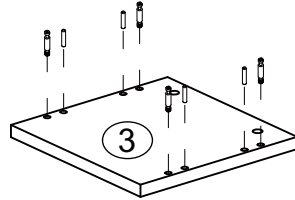
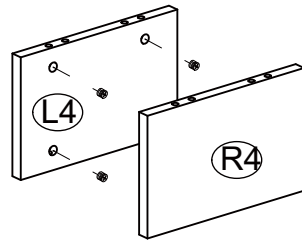

Step 1.1

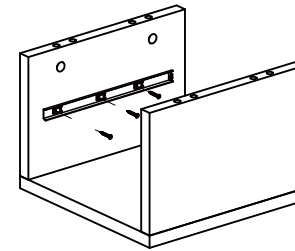

Step 1.2

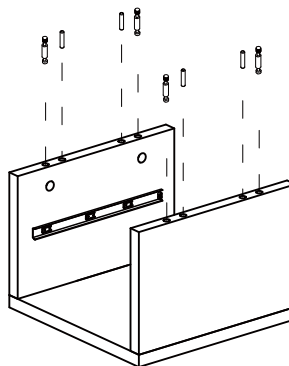
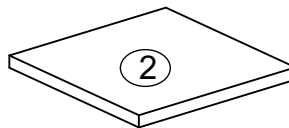

Step 1.3

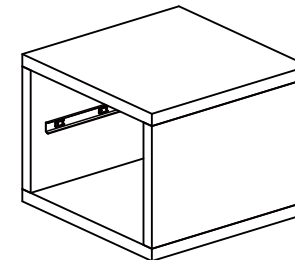

Step 1.4

# ASSEMBLY INSTRUCTIONS

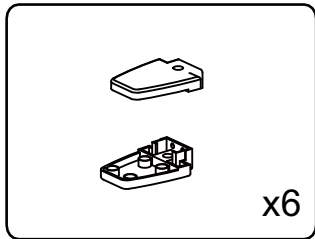

(P5) Glass Glamp

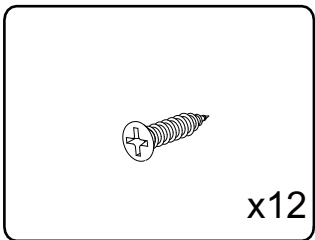

(P6) Tapping Screw

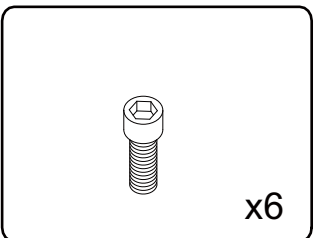

(P7) Screw

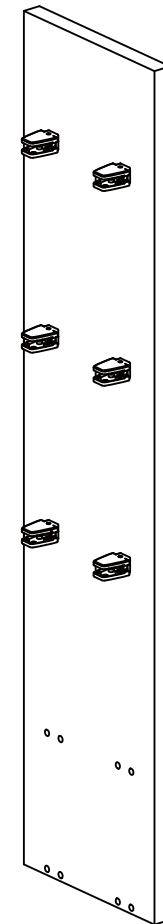
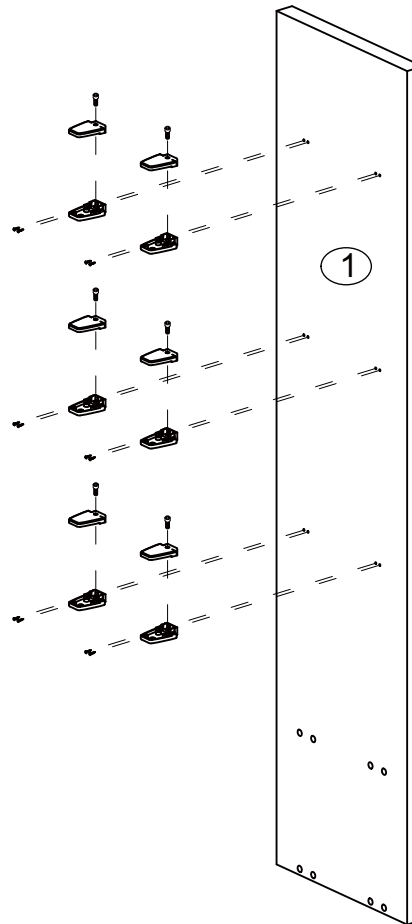

Step 2

## ASSEMBLY INSTRUCTIONS

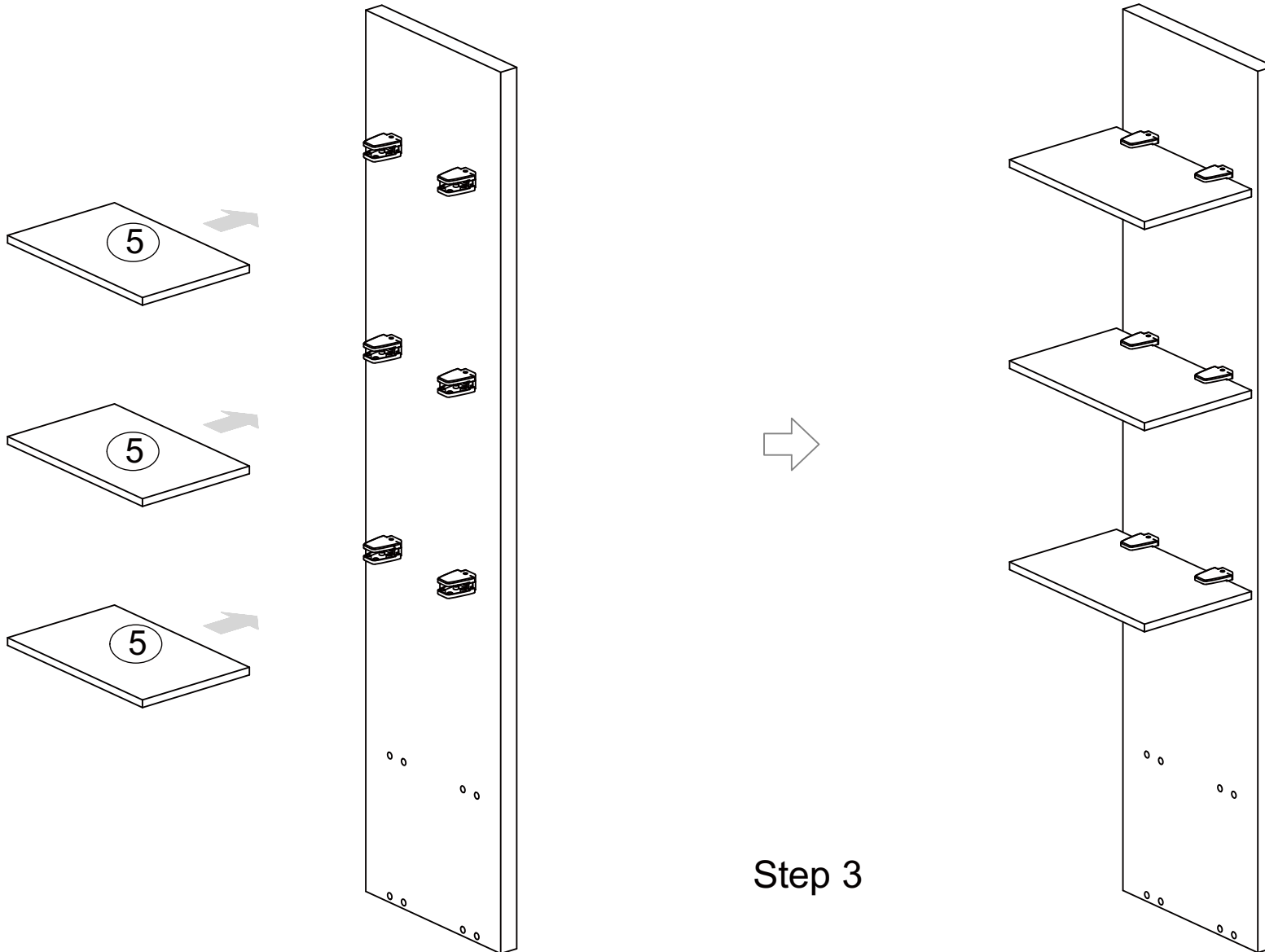

Step 3

# ASSEMBLY INSTRUCTIONS

# DIR

www.dirgroup.co.uk

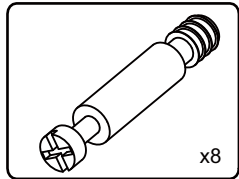

P1 Ø6X32mm

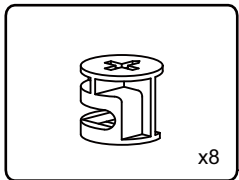

P2 Ø15X12mm

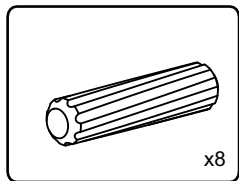

P3 Ø8X40mm

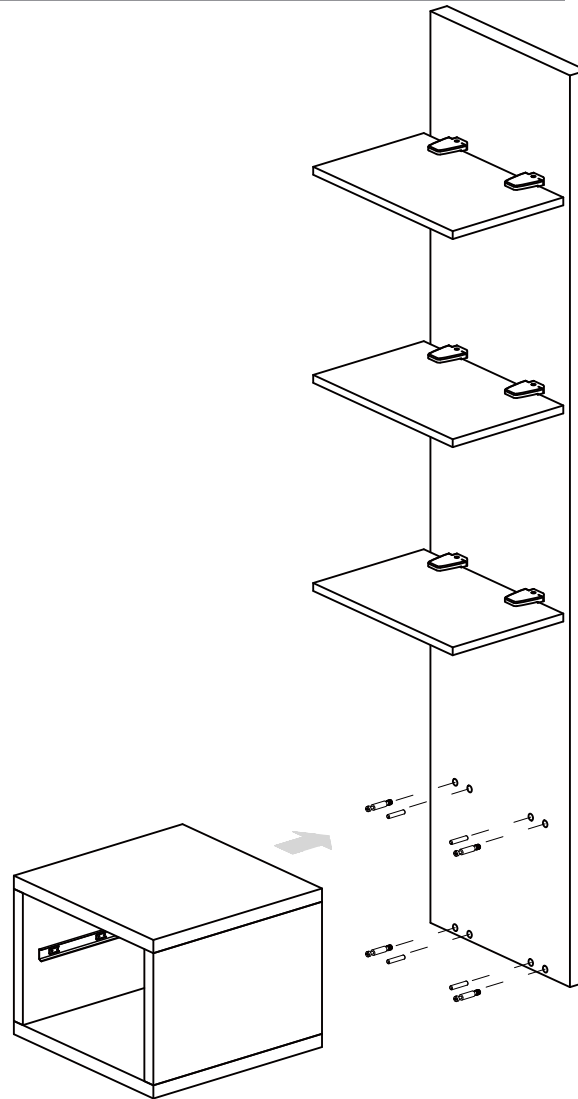

Step 4

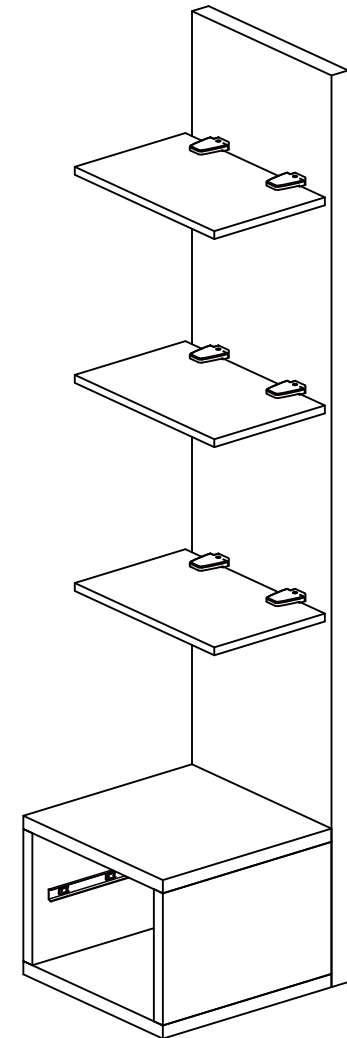

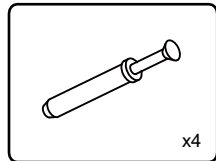

(P8) Expansion bolts

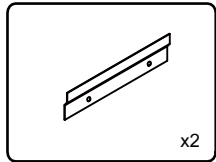

(P9) Hanger

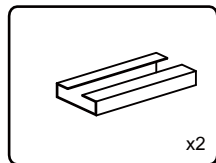

(P10) Groove

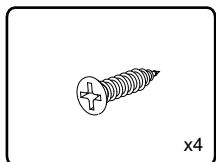

(P6) Tapping Screw

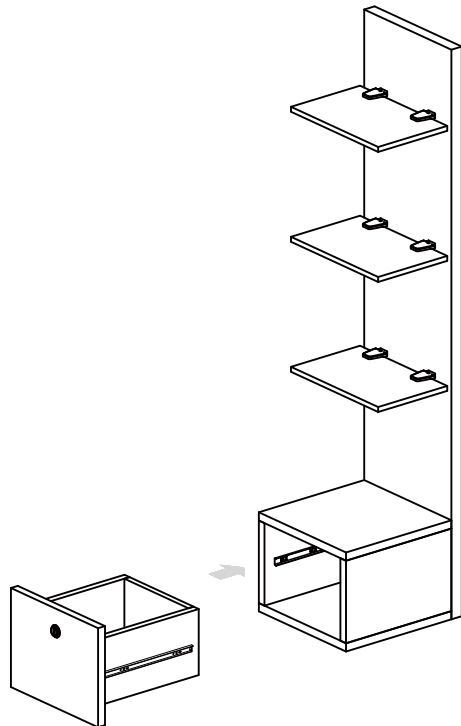

Step 5.1

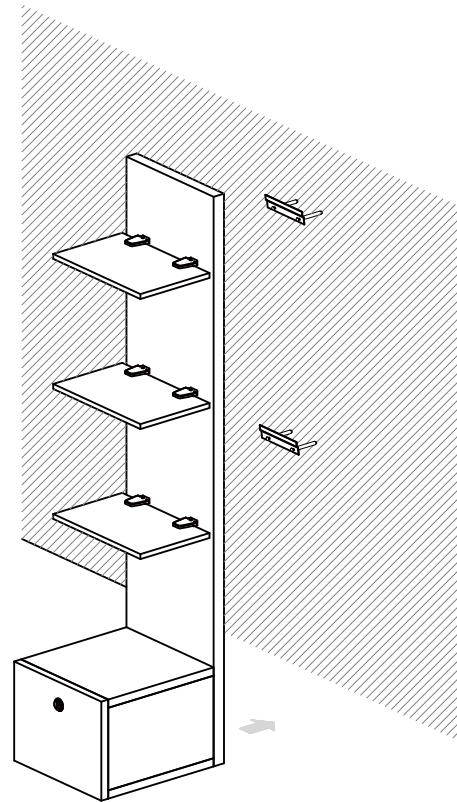

Step 5.2

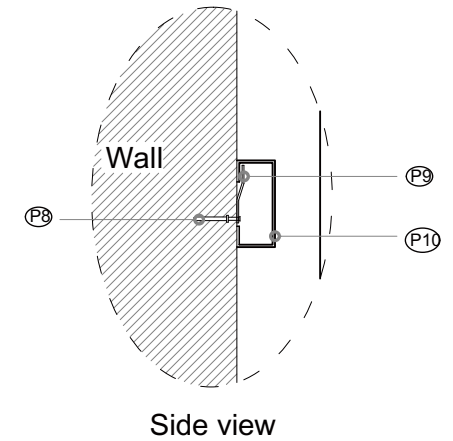

Secure the hanger on the wall by the provided expansion bolts and secure the mirror on the wall by the hanger.

# ASSEMBLY INSTRUCTIONS

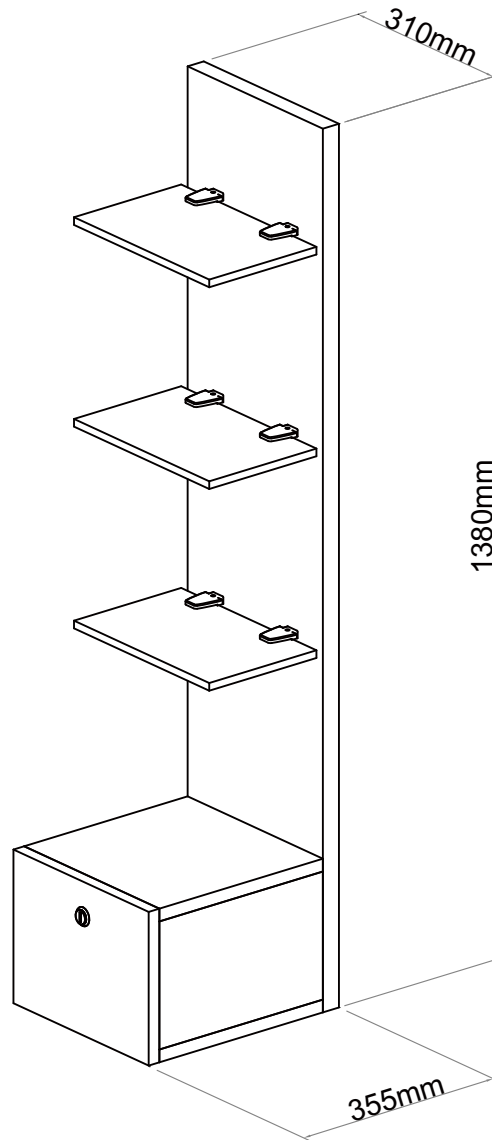

Assembly complete

## AFTERCARE INSTRUCTIONS

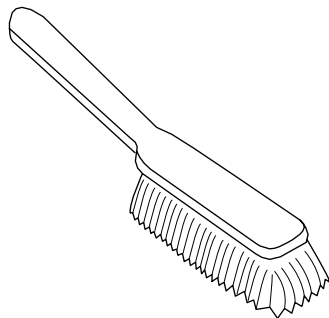

Brush away excess hair

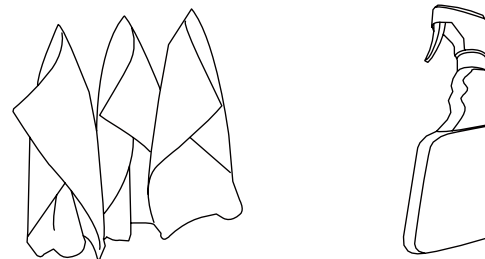

Wipe clean with a cloth dampened in a mild leather cleaner or wipe dry with a clean cloth

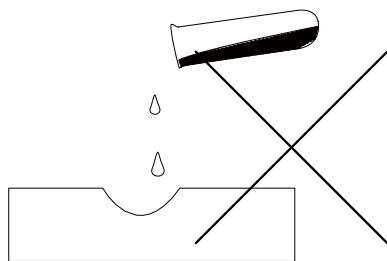

Avoid the use of abrasives, bleaches or solvents

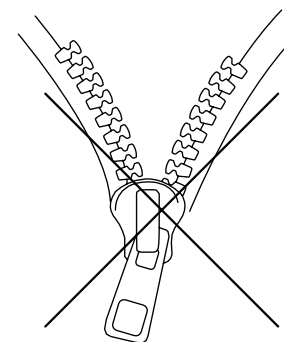

Never remove and wash leather covers

After an initial period of use, check all fastenings for any loosened screws etc. If found, please tightened appropriately

## CONTACT US

### DIR BIRMINGHAM (HEADQUARTERS)

66 Rea Street South  
Birmingham  
B5 6LR  
UK  
Sales: +44(0)800 085 3667  
Customer Service: +44(0)121 6433877  
Fax: +44(0)121 6333291  
Email: sales@dirgroup.co.uk  
Website: www.dirgroup.co.uk

### DIR LONDON

Unit 1 River Road Business Park  
33 River Road, Barking  
Greater London IG11 0DA  
UK  
Sales: +44(0)20 8591 9310  
Fax: +44(0)20 8594 4147  
Email: sales.london@dirgroup.co.uk  
Website: www.dirgroup.co.uk

### DIR NEW YORK

24 Woodward Ave.  
Suite C  
Queens, NY 11385  
USA  
Sales: +1 (718)628-6668  
+1 (800)728-2008  
Fax: +1 855-628-5168  
Email: sales@dirsalonfurniture.com  
Website: www.dirsalonfurniture.com

### DIR COLOGNE

Konrad-Adenauer-Straße 25  
50996 Köln  
Germany  
Sales: + 49 (0) 221 / 88888.128  
Fax: + 49 (0) 221 / 88888.122  
Email: sales@dirgroup.de  
Website: www.dirgroup.de

### DIR IRELAND

Unit 5 Block E  
Riverview Business Park  
Nangor Road  
Dublin 12  
Republic of Ireland  
Sales: +353 (01) 429 7969  
Email: sales.ireland@dirgroup.ie  
Website: www.dirgroup.ie

### FOLLOW US



If you have any enquires regarding the product warranty, please contact our customer services team.



**[www.dirgroup.co.uk](http://www.dirgroup.co.uk)**