

Paris

3401

INSTRUCTION MANUAL

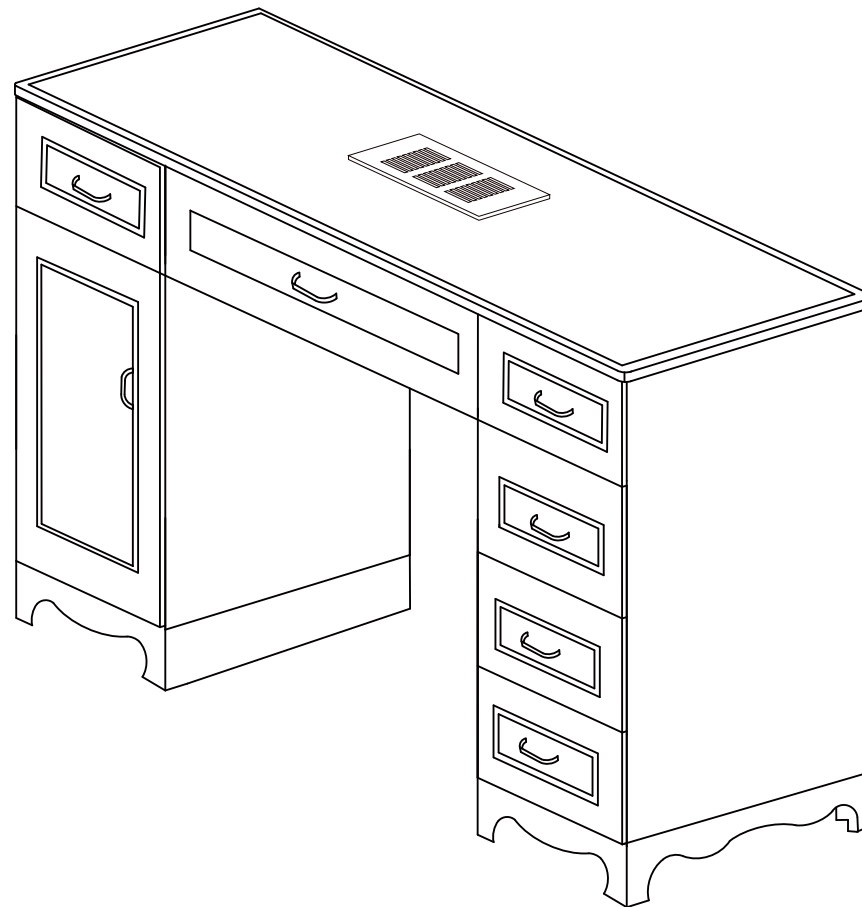

EN

CONTENTS

Product Introduction	3
Warranty	4
Assembly Instructions	5
_List of Parts	5
_Tools Necessary	7
_Instructions	8
Aftercare Instructions	16
Contact Us	17

Please read the operation manual before using the product.

Please put the operation manual in the place easy for you to read and you can read it at any time.

Product Name: Paris
Product Code: 3401

The warranty period is one years. Dream In Reality Group warrants to you, the original buyer, that goods shall be free of defects in material and/or workmanship attributable to manufacture for one years from date of buyer's receipt of product. Damage resulting from improper handling after merchandise is received, or from exposure to weather or extreme atmospheric conditions is not covered by the warranty. For any other information please contact our support team on +44(0)121 6433877

WARRANTY

The warranty period is one year. DIR warrants to you, the original buyer, that goods shall be free of defects in material and/or workmanship attributable to manufacture for one year from date of buyer's receipt of product. Damage resulting from improper handling after merchandise is received, or from exposure to weather or extreme atmospheric conditions is not covered by the warranty.

For any other information please contact our support team:

DIR BIRMINGHAM	DIR LONDON	DIR NEW YORK	DIR COLOGNE	DIR IRELAND
66 Rea Street South Birmingham B5 6LR UK ----- Tel: +44(0)121 6433877 ----- Email: sales@dirgroup.co.uk	Unit 1 River Road Business Park 33 River Road, Barking Greater London IG11 0DA UK ----- Tel: +44(0)20 8591 9310 ----- Email: sales.london@dirgroup.co.uk	24 Woodward Ave. Suite C Queens, NY 11385 USA ----- Tel: +1 (718)628-6668 +1 (800)728-2008 ----- Email: sales@dirsalonfurniture.com	Konrad-Adenauer-Straße 25 50996 Köln Germany ----- Tel: + 49 (0) 221/88888.128 ----- Email: sales@dirgroup.de	Unit 5 Block E, Riverview Business Park, Nangor Road, Dublin 12 Republic of Ireland ----- Tel: +353 (01) 429 7969 ----- Email: sales.ireland@dirgroup.ie

ASSEMBLY INSTRUCTIONS

List of Parts

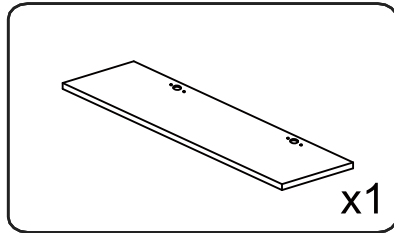

Foreplate 55x16.5cm

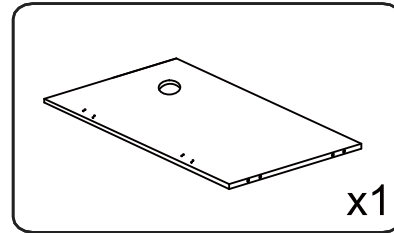

Baseplate 55x41.7cm

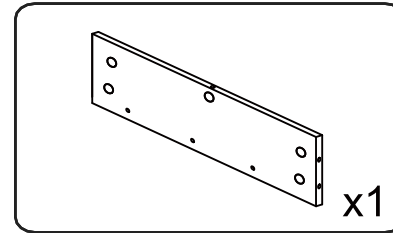

Backboard 55x16.5cm

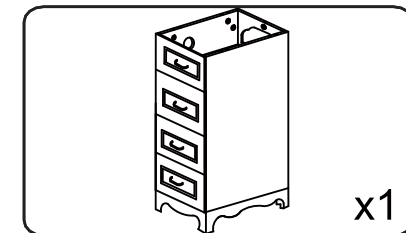

The right ark 77x49x32cm

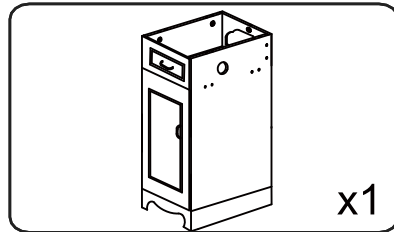

The left ark 77x49x32cm

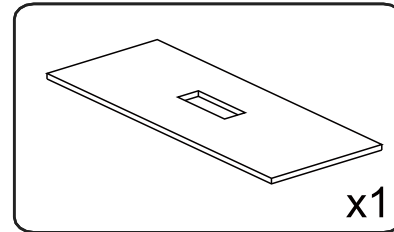

Top plate 120.5x51.5cm

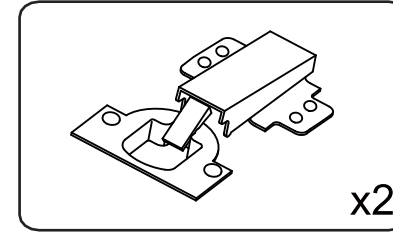

Hinge

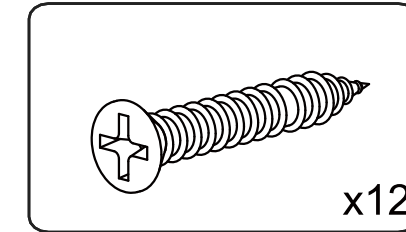

Ø4X15mm

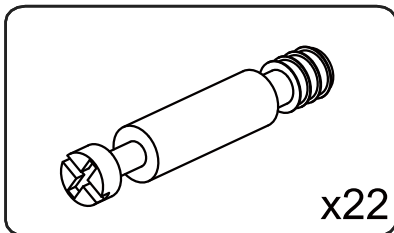

Ø6x32mm

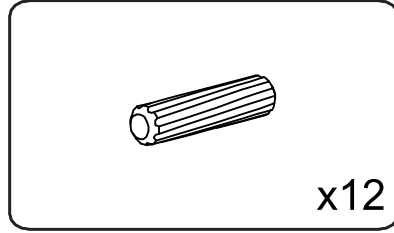

Pillar Ø8x40mm

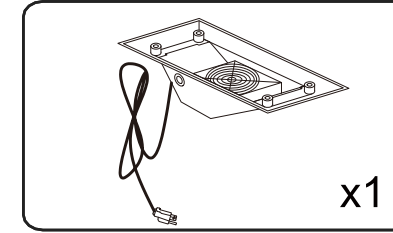

Dust collector

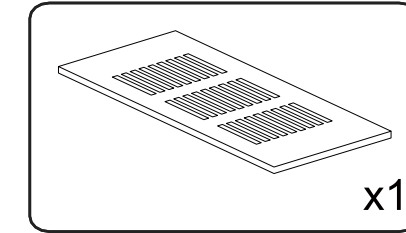

Support

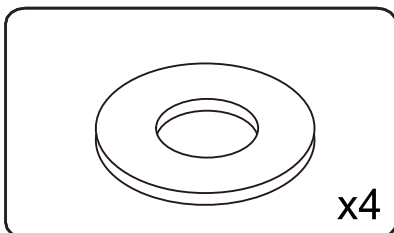

x4

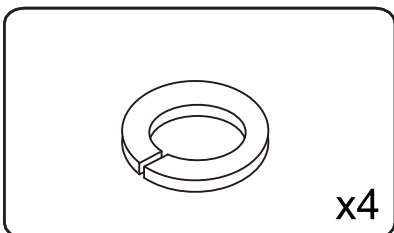

x4

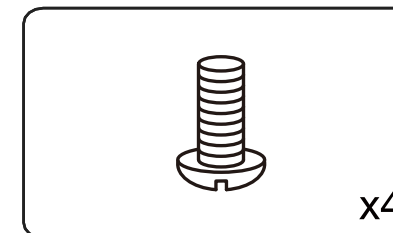

Ø6X10mm



ASSEMBLY INSTRUCTIONS

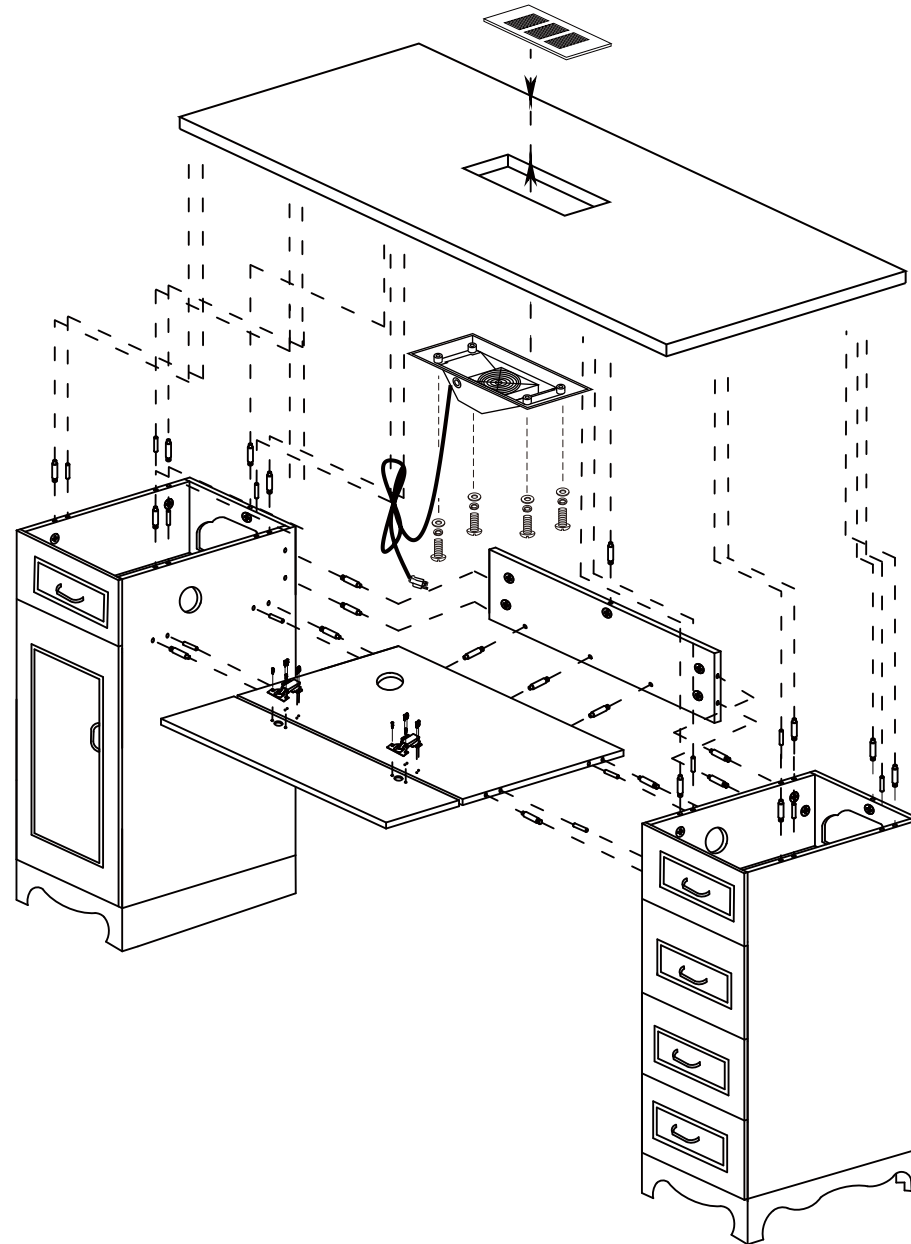

ASSEMBLY INSTRUCTIONS
Tools Necessary

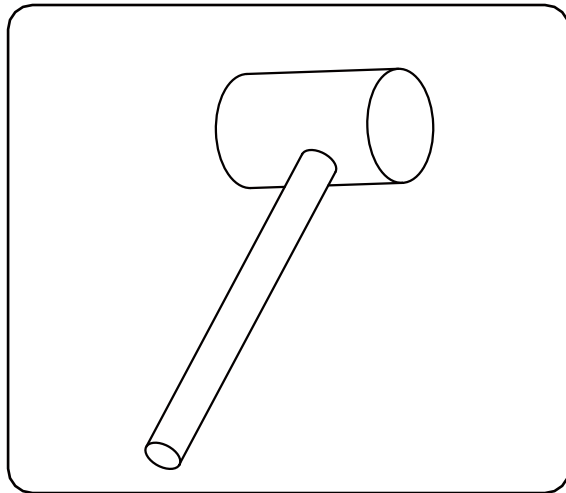

Rubber Hammer

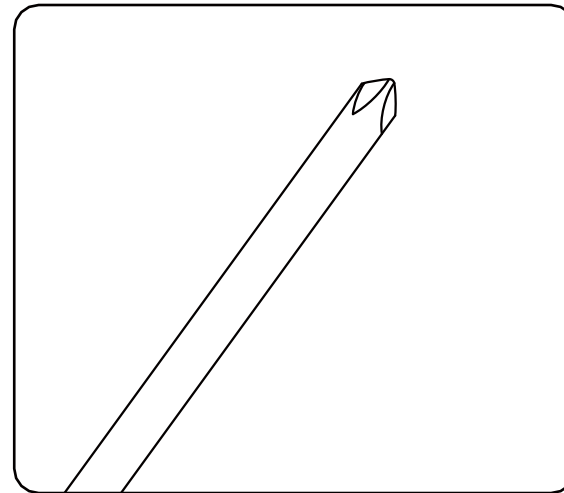

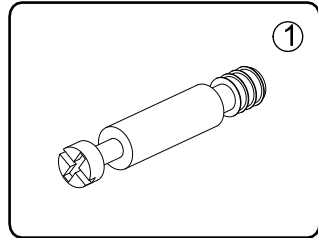

Cross screwdriver

ASSEMBLY INSTRUCTIONS

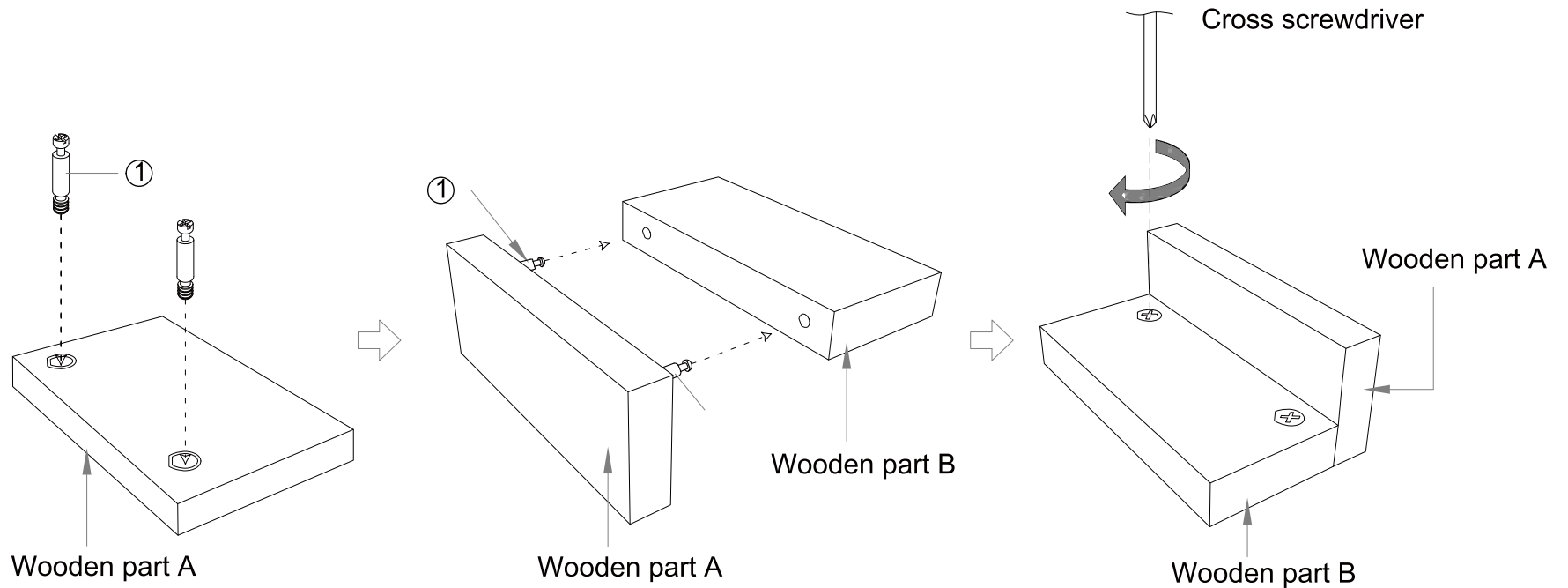

Assembly Techniques Display



 Please put parts together with full 2 techniques instructions for every assembly step in the following pages.

ASSEMBLY INSTRUCTIONS

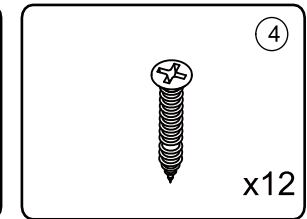
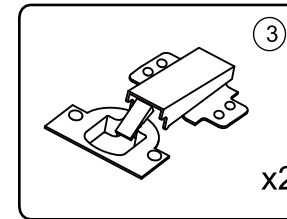
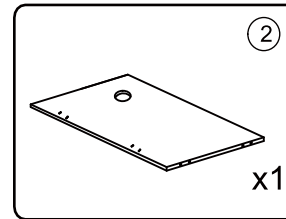
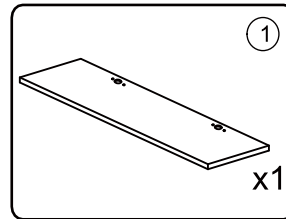

Step1

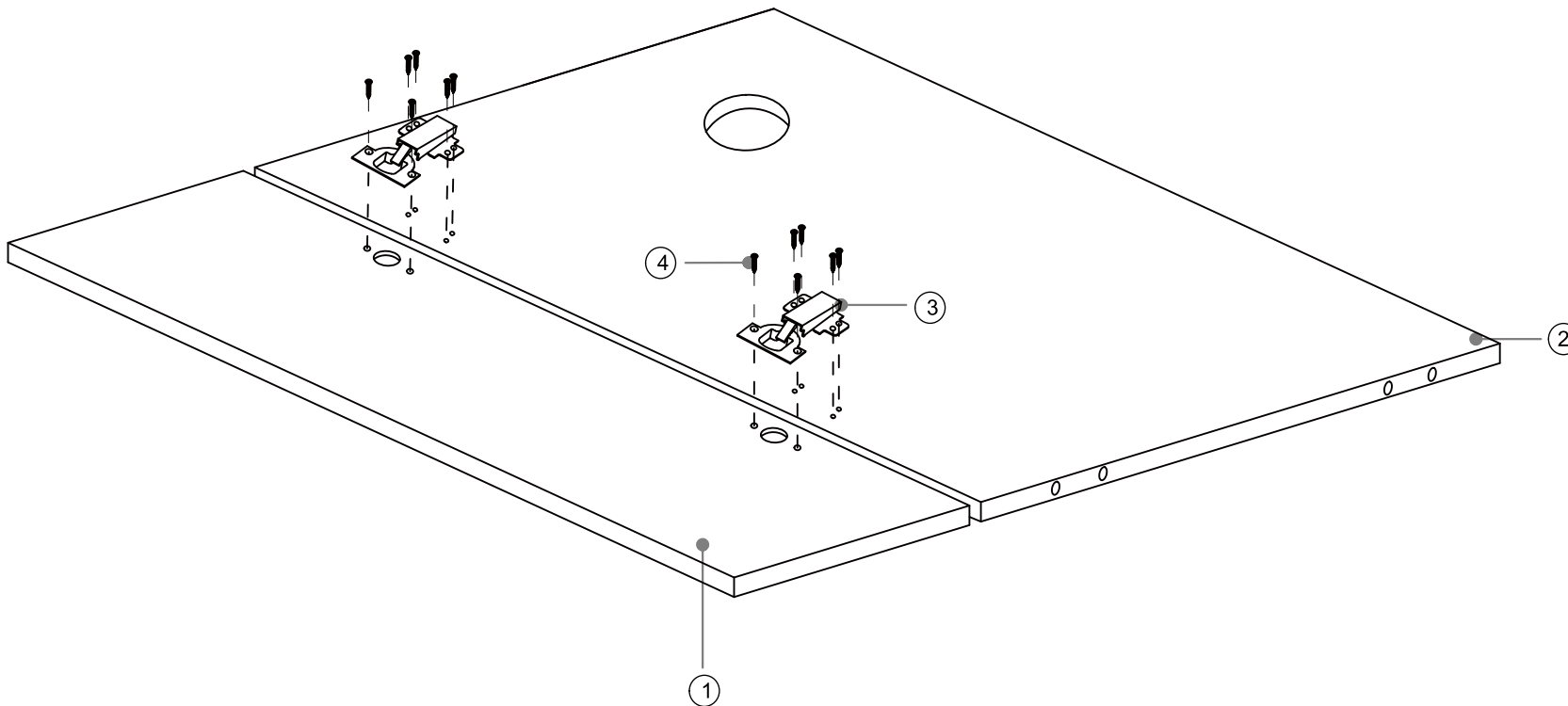

ASSEMBLY INSTRUCTIONS

DIR

www.dirgroup.co.uk

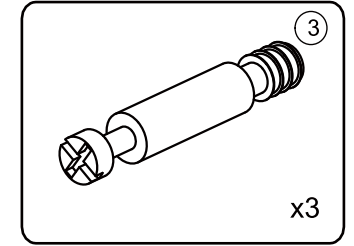
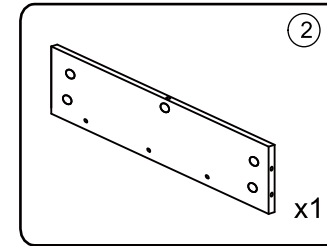
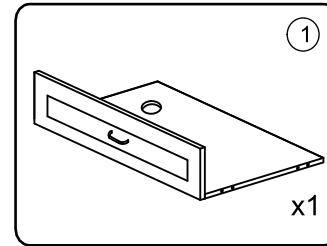

Step2

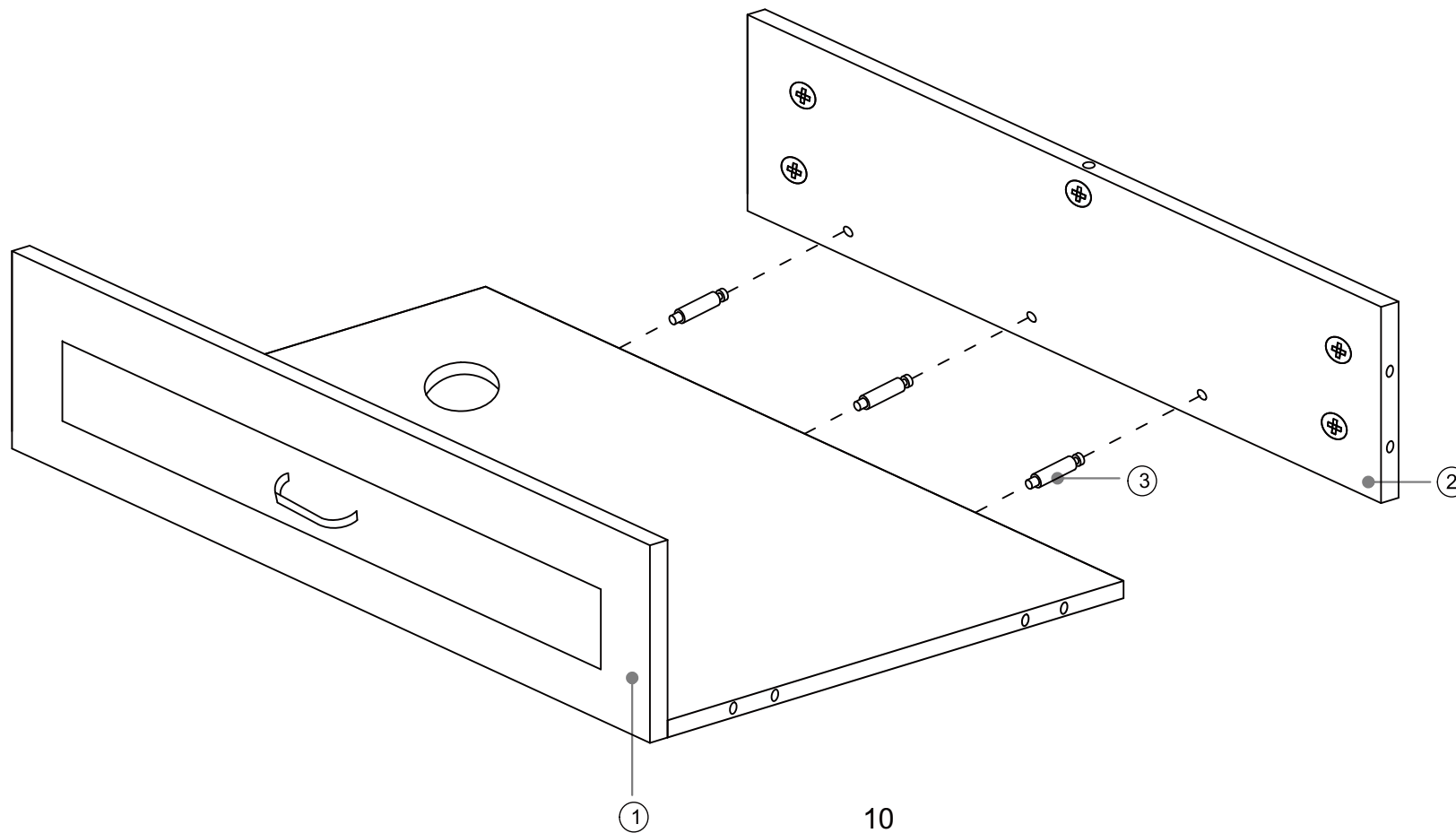

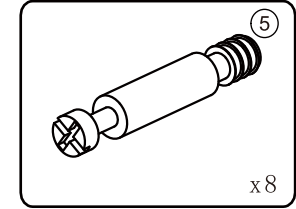
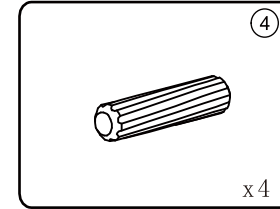
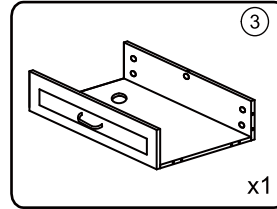
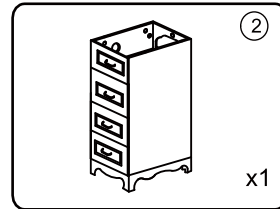
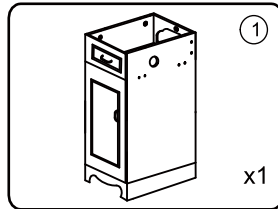

Step3

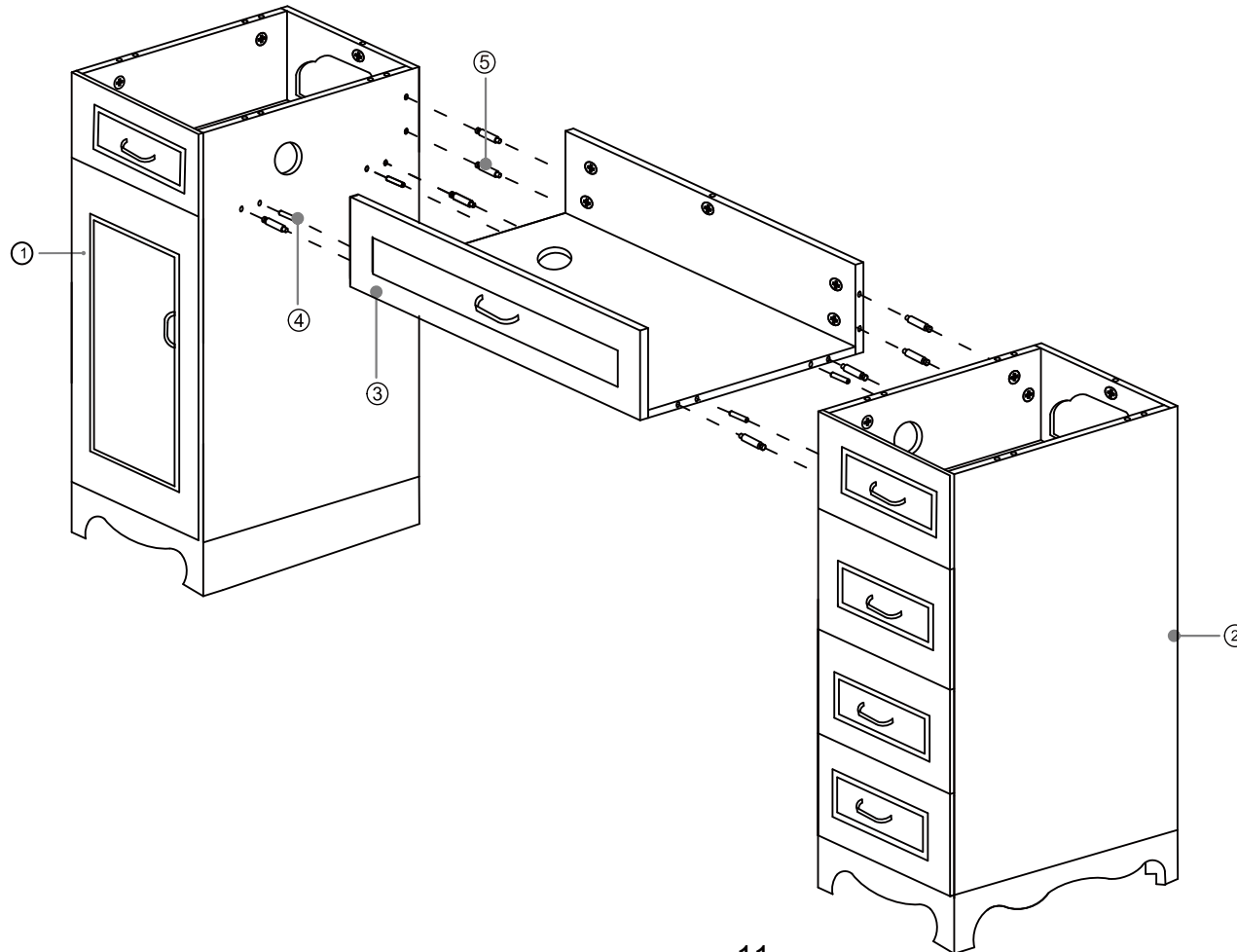

ASSEMBLY INSTRUCTIONS

DIR

www.dirgroup.co.uk

Step 4

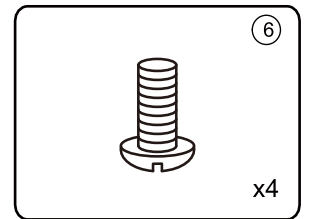
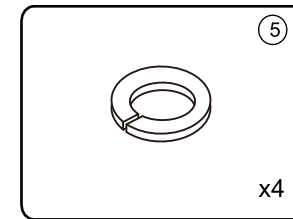
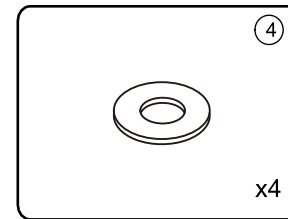
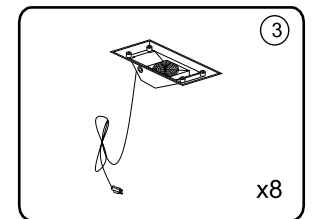
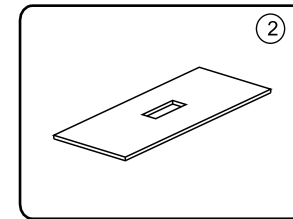
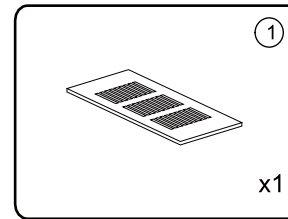
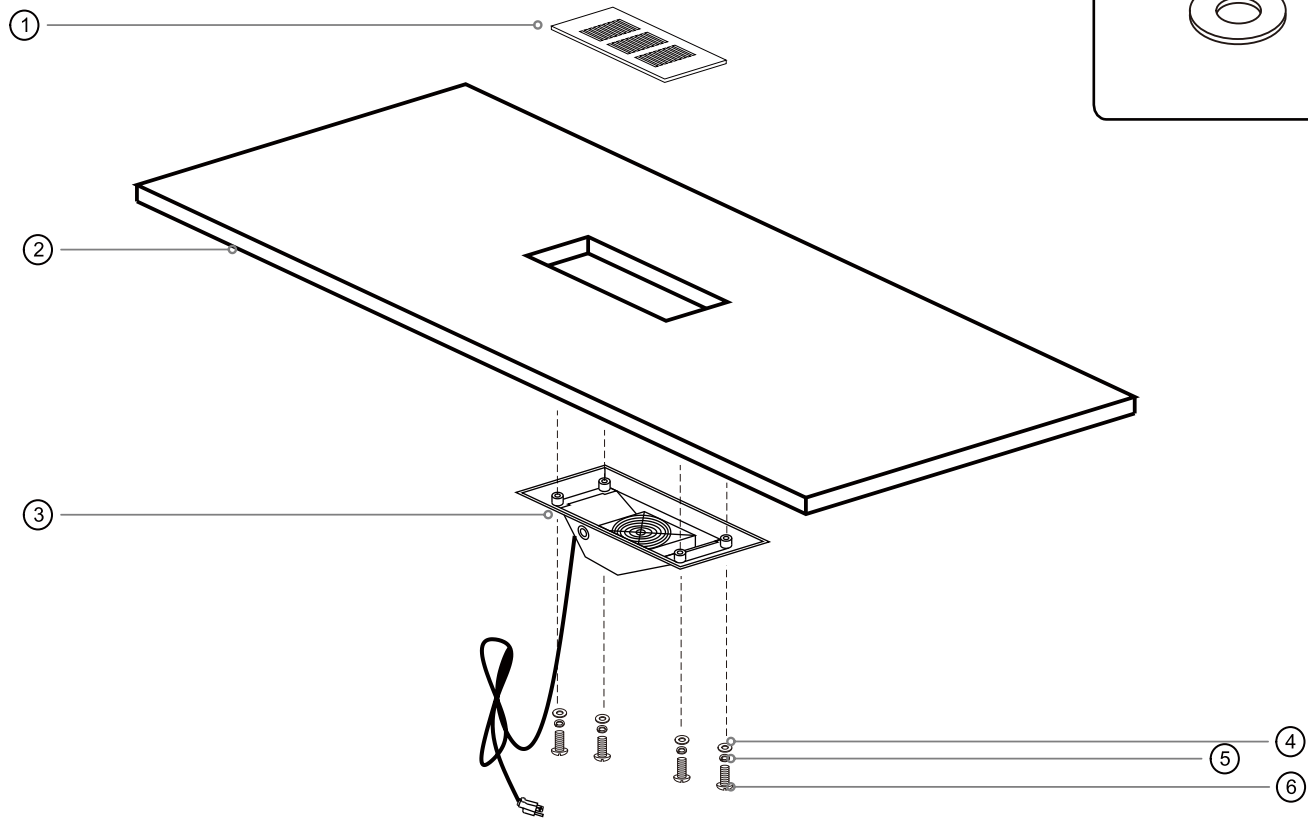

Step 5

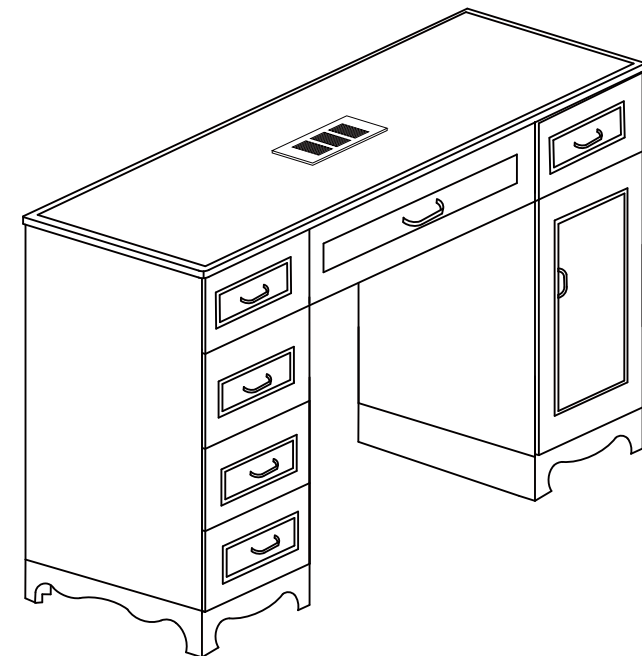
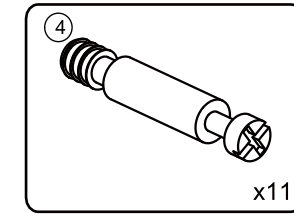
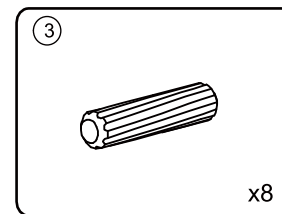
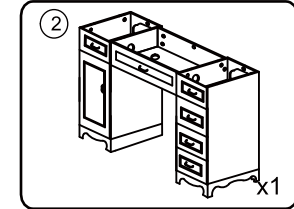
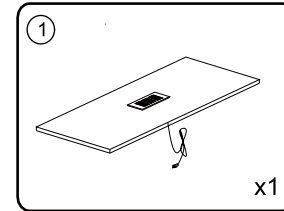
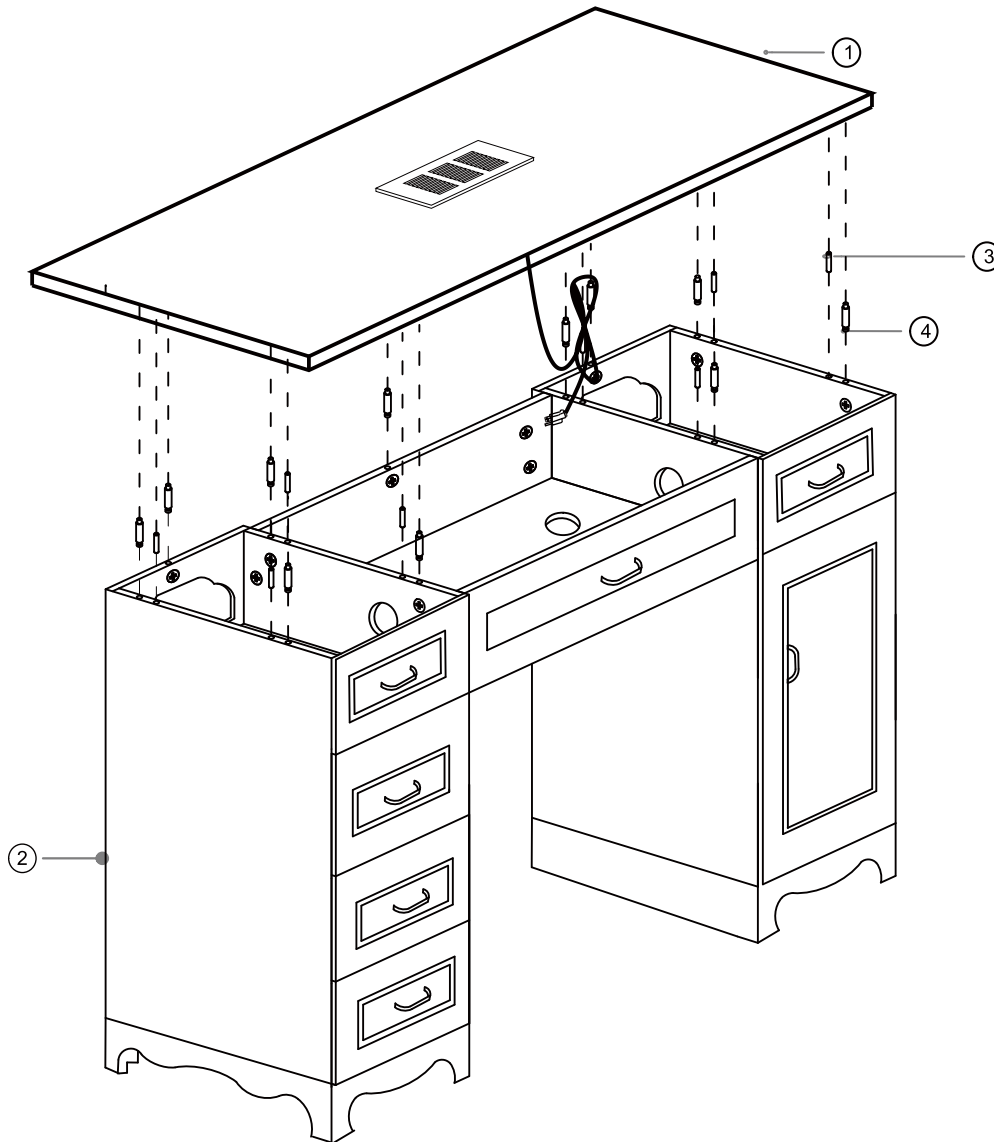

ASSEMBLY INSTRUCTIONS

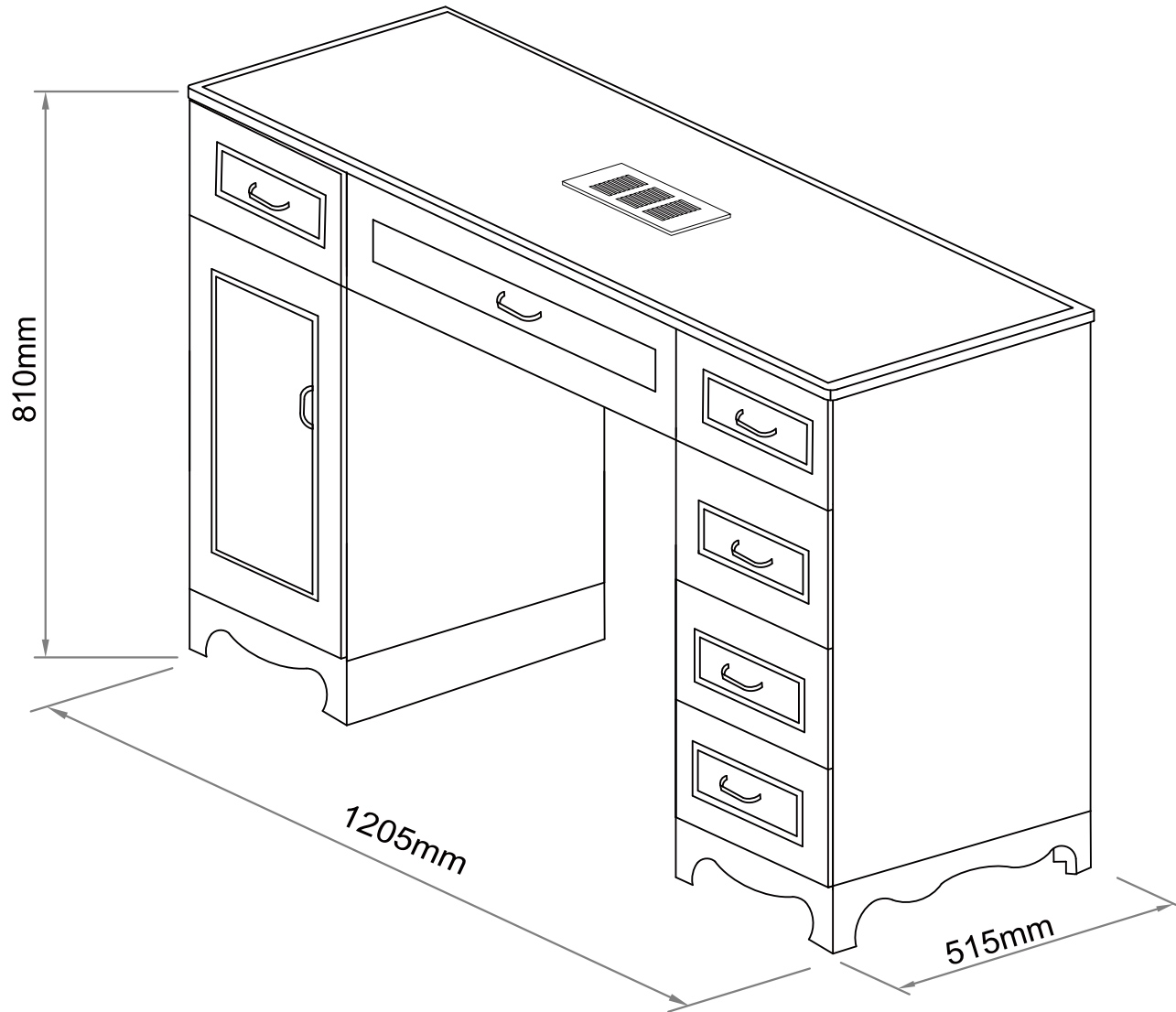

AFTERCARE INSTRUCTIONS

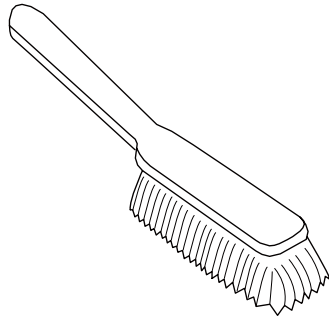

Brush away excess hair

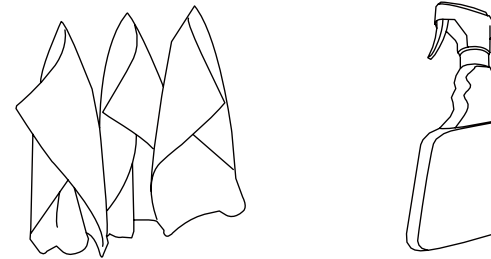

Wipe clean with a cloth dampened in a mild leather cleaner or wipe dry with a clean cloth

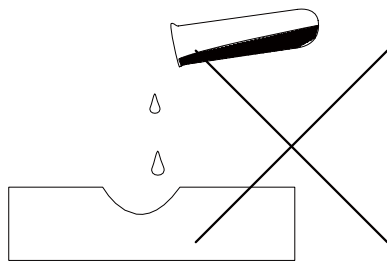

Avoid the use of abrasives, bleaches or solvents

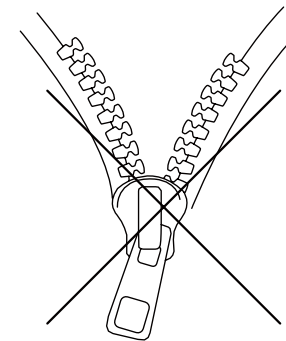

Never remove and wash leather covers

After an initial period of use, check all fastenings for any loosened screws etc. If found, please tightened appropriately

CONTACT US

DIR BIRMINGHAM (HEADQUARTERS)

66 Rea Street South
Birmingham
B5 6LR
UK
Sales: +44(0)800 085 3667
Customer Service: +44(0)121 6433877
Fax: +44(0)121 6333291
Email: sales@dirgroup.co.uk
Website: www.dirgroup.co.uk

DIR LONDON

Unit 1 River Road Business Park
33 River Road, Barking
Greater London IG11 0DA
UK
Sales: +44(0)20 8591 9310
Fax: +44(0)20 8594 4147
Email: sales.london@dirgroup.co.uk
Website: www.dirgroup.co.uk

DIR NEW YORK

24 Woodward Ave.
Suite C
Queens, NY 11385
USA
Sales: +1 (718)628-6668
+1 (800)728-2008
Fax: +1 855-628-5168
Email: sales@dirstalonfurniture.com
Website: www.dirstalonfurniture.com

DIR COLOGNE

Konrad-Adenauer-Straße 25
50996 Köln
Germany
Sales: + 49 (0) 221 / 88888.128
Fax: + 49 (0) 221 / 88888.122
Email: sales@dirgroup.de
Website: www.dirgroup.de

DIR IRELAND

Unit 5 Block E
Riverview Business Park
Nangor Road
Dublin 12
Republic of Ireland
Sales: +353 (01) 429 7969
Email: sales.ireland@dirgroup.ie
Website: www.dirgroup.ie

FOLLOW US



DIRSalon



DIRSalon

If you have any enquires regarding the product warranty, please contact our customer services team.

www.dirgroup.co.uk