

















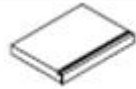
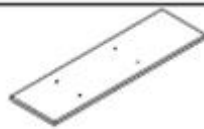
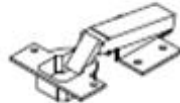

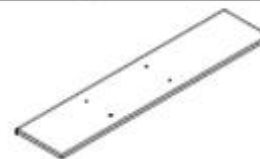

	W635	67		250*248*15	3	H		765*265*15	1	O
	W1510	67		300*150*15	3	I		1023*770*15	1	P
	M420	8		300*150*15	3	I1		1023*400*25	1	Q
	E	4		164*150*15	3	J		875*250*15	1	R
	F	2		174*294*5	3	K		1075*250*15	1	S
	M416	12		220*363*15	2	L		198*246*15	2	T
	W440	19		770*365*15	1	M		1020*1090*15	1	U
	H1	1		770*365*15	1	M1		220*363*15	1	W
	M412	12		770*365*15	1	N				
	J1	2		770*365*15	1	N1				

1.

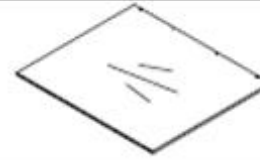

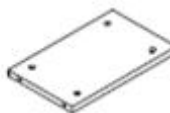
2.

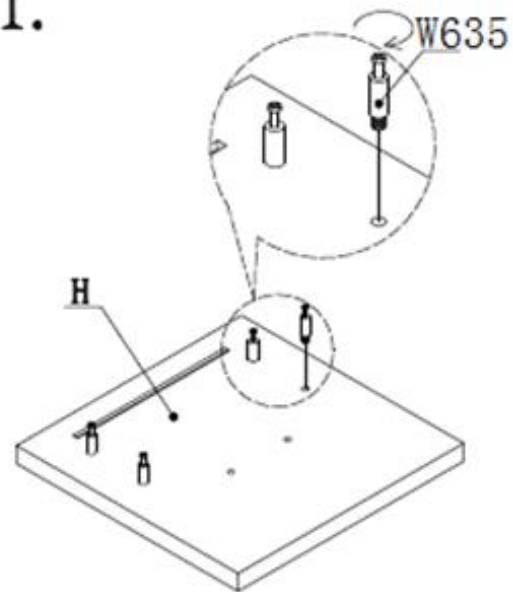
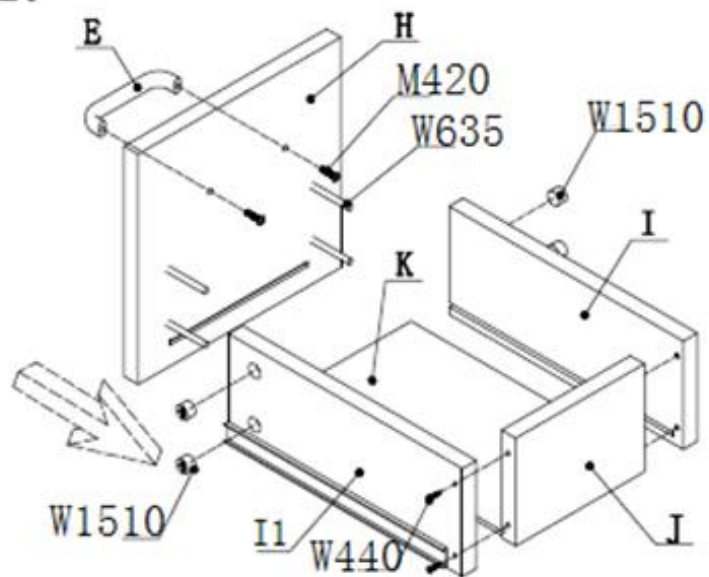

3.

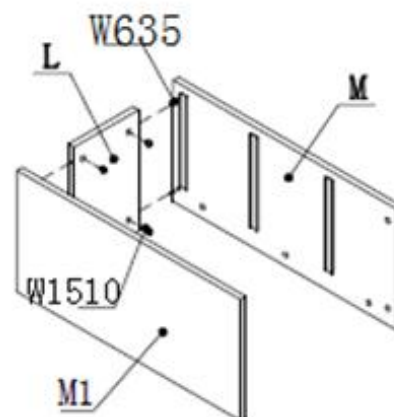

4.

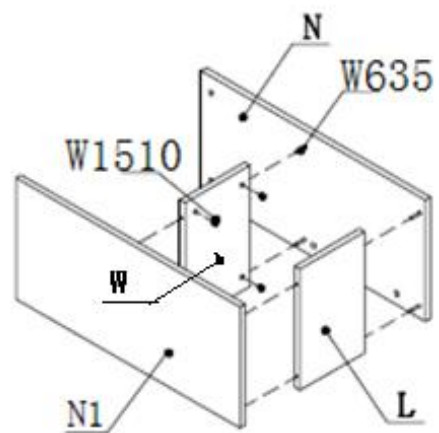

5.

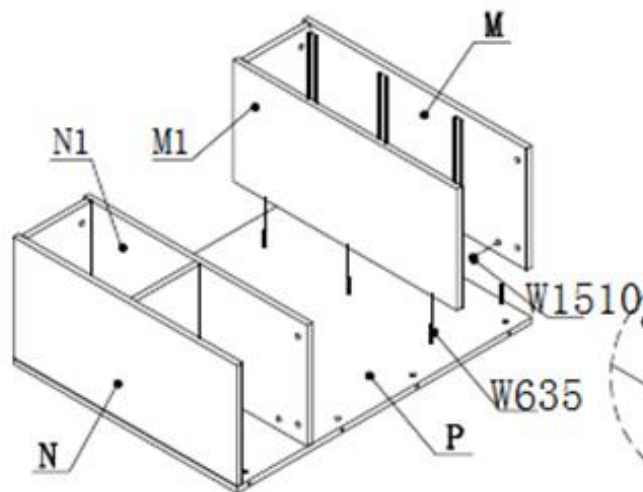

6.

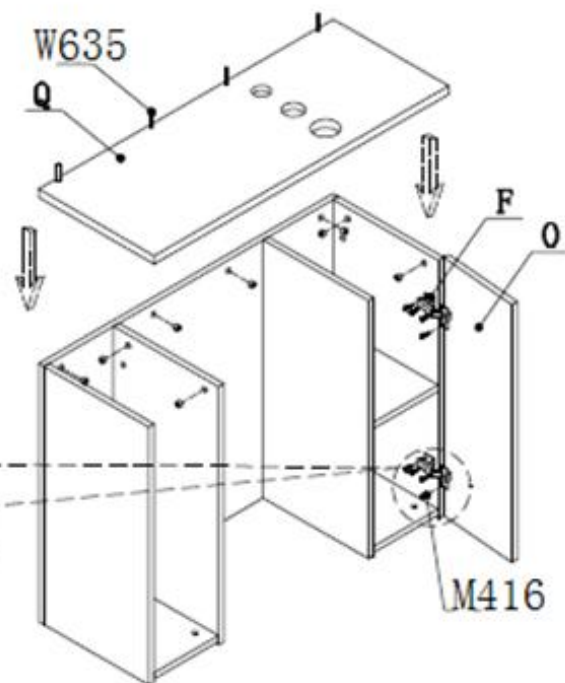

7.

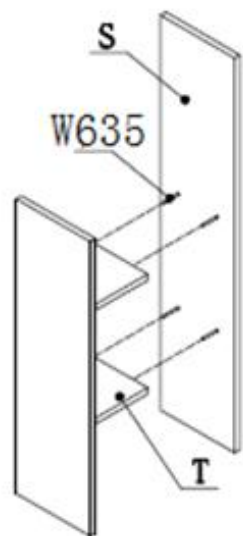

9.

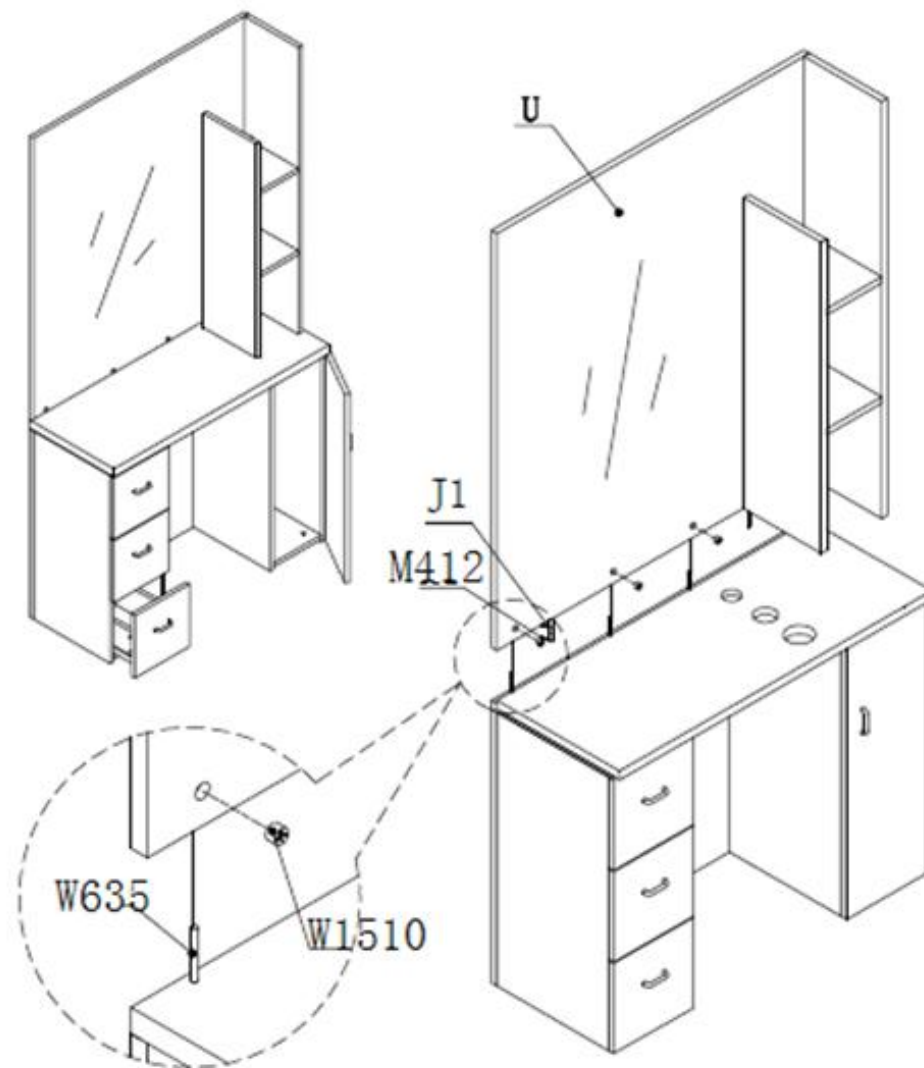

8.

