

Pro Charge Ultra Instruction Manual



WARNING HIGH VOLTAGE

This product requires a knowledge of both AC and DC electrical installation. Please do not install this product unless you are qualified to do so. All effort is made to make the instructions as safe as possible but it is not possible to cover all electrical safety and installation aspects. Sterling can only assume a certain basic knowledge is held by the installer. **Only to be installed by qualified personnel.**

DANGER HIGH VOLTAGE

TO AVOID SERIOUS INJURY OR DEATH FROM ELECTRICAL SHOCK. BEFORE PERFORMING ANY ELECTRICAL WORK ENSURE YOU TURN OFF AND REMOVE ANY AC POWER AND CHECK VOLTAGES TO MAKE SURE THE CIRCUIT IS OFF.

DANGER EXPLOSION HAZARD

TO AVOID SERIOUS INJURY OR DEATH MAKE CONNECTIONS IN A WELL VENTILATED ATMOSPHERE FREE FROM EXPLOSIVE FUMES. IT IS ADVISABLE TO WEAR SAFETY GOGGLES WHEN WORKING NEAR BATTERIES.

DANGER LOW VOLTAGE

TO AVOID SERIOUS INJURY OR DEATH FROM ELECTRICAL BURNS & SPARKS ENSURE YOU DISCONNECT ANY DC POWER AND CHECK VOLTAGES TO MAKE SURE THE CIRCUIT IS OFF BEFORE PERFORMING ANY ELECTRICAL WORK.

CAUTION HIGH TEMPERATURE

HOT SURFACES - TO REDUCE RISK OF BURNS DO NOT TOUCH THE UNIT WHEN IN SERVICE.

ONLY CHARGE THE CHEMISTRY PROFILES WHICH ARE COVERED BY THE PRESET VALUES OF THE UNIT. IF CUSTOM SET, VALUES MUST ADHERE TO THAT OF THE BATTERY MANUFACTURE. GETTING THE VALUES WRONG COULD LEAD TO GASSING AND EXPLOSION OF BATTERIES. ONLY USE THIS CHARGER WITH LITHIUM- LiFePO₄ BATTERIES IN CONJUNCTION WITH A *Battery Management System* FOR FAILURE TO FIT A B.M.S. COULD RESULT IN A FIRE.

12V / 60A model, all other units pro rata.

Input voltage range	80-270V 40-70 Hz
Power Factor at 230V	0.976
Efficiency	90.4%
Full load current (110/230V)	9.8/4.6A
Total Harmonic Distortion	2.4% voltage
Total Harmonic Distortion	2.4% current
Ripple noise (R.M.S.)	14mV
Ground leakage	0.5 mA
Generator/ mains power (watts)	
12V 20A approx	350W
12V 30A approx	500W
12V 40A approx	600W
12V 50A approx	750W
12V 60A approx	900W
24V 20A approx	600W
24V 30A approx	900W
36V 20A approx	900W (NOT UL / CEC LISTED)
48V 15A approx	900W (NOT UL / CEC LISTED)
voltmeter accuracy	+/- 1%
Ammeter accuracy	+/- 1%

To Standards: Pro Charge ULTRA

UL 1236 SB
 CSA C22.2-107.2
Tested to CE standards
 EN61000-3-2 EN61000-3-3
 EN55014-1 EN 55014-2
 EN60335-2-29
 CEC listed

Sterling Power

GLOBAL AC Input & Active Power Factor Correction

Progressive DIGITAL software control Charger / Powerpack

www.sterling-power.com CEC approved www.sterling-power-usa.com

AC Power 14.6 Volts Charger Output 6.0 Amps

Auto Temp Control Multi Speed Fan 0% 100%

Active PFC

CHARGER MODE: Stand-by, Battery Health Program, Float

System self test, De-sulphation, CHARGE INFORMATION

Battery Type: Open lead acid, Sealed lead acid, A.G.M, GEL, Lithium (LiFePO₄), Calcium / Custom

OK, Fault, High Voltage Trip, High Charger temp trip, Check Fan

RoHS compliant, CE, TÜV SUD NRTL US, C, RoHS compliant

EN ISO 13297 Small Craft Directive

For Multi battery type and voltages Complementary addition:

Battery Chemistry Module (BCM).

Allows for multiple chemistry charging simultaneously from one charger (different battery types). Also allows for 24V charging from 12V charger. **Read page 5.**



PCU Top Functions:

- 1) 11 preprogrammed battery curves including LiFePO₄.
- 2) 1 custom set, can be set from charger, no need for computer.
- 3) 2 x digital meters for current and voltage measurement.
- 4) 1 x power meter to show what reserve power left on the unit.
- 5) Active PFC, up to 0.99 pf, ensuring efficient power conversion
- 6) Synchronized rectification output as opposed to diode output (+10% efficiency)
- 7) High voltage de-sulphation cycle.
- 8) New, low activity, standby mode to increase battery life.
- 9) Battery health program.
- 10) Multiple speed fan control to reduce unnecessary fan noise.
- 11) Primary (processor digitally controlled) and an emergency backup.
- 12) 32 LED information panel.
- 13) Internal scan and systems check.
- 14) Remote control.
- 15) Small footprint and light weight.
- 16) Include battery temperature sensor.
- 17) **USA CEC listed (default setting is on, CEC can be turned off). CEC regulation stipulates that the charger is only on when necessary. This reduces AC power consumption and lowers operational costs, while maintaining healthy batteries.**
- 18) % power reduction to allow unit to work with restricted input power.
- 19) Conforms to A.B.Y.C. drip test. Waterproof when water is dropped directly on to the top of the unit (+/- 17 degrees) if installed correctly (vertically).
- 20) The printed circuit boards are conformal coated for high humidity operations.

Installation

- 1) Install in cool dry well ventilated space.
- 2) This product has a high heat tolerance and can be installed in an engine room.
- 3) This product is ignition protected and can be installed near the batteries.
- 4) Charger MUST be installed vertically to allow for convection air flow and also in the vertical position
- 5) The product is drip proof.
- 6) The product will work in any position but we cannot guarantee the drip proof aspect (only vertically).

Quick LED feature guide

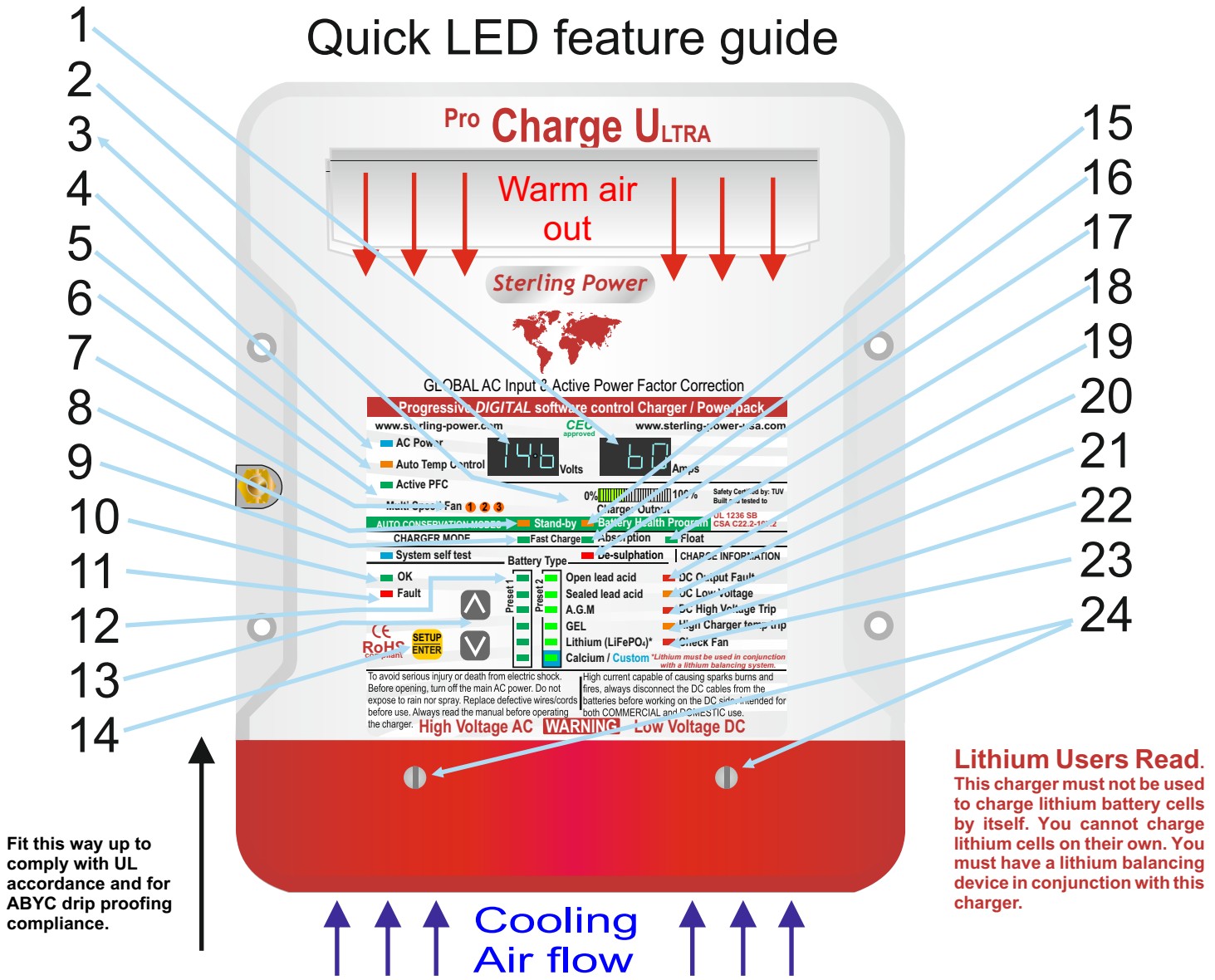

Fit this way up to comply with UL accordance and for ABYC drip proofing compliance.

Lithium Users Read.
This charger must not be used to charge lithium battery cells by itself. You cannot charge lithium cells on their own. You must have a lithium balancing device in conjunction with this charger.

- 1) Ammeter, shows the total current being produced by the charger.
- 2) Voltmeter, showing the average voltage being produced by the charger.
- 3) Power meter, shows the % power being produced by the unit and the remaining power available.
- 4) AC power, shows the AC power is connected and the product is live. LED flashes if power is available but the unit is switched off (see on/off later) push buttons. Setup and up arrow for 5 secs to activate.
- 5) Auto temp control, shows the battery temp sensor is connected and operational. If sensor not connected then the unit will default to a 20 deg C / 69 F charge curve.
- 6) Shows that the active PFC (Power Factor Correction) is on.
- 7) Fan speed control, varies depending on temp, 3 speeds.
- 8) Standby, charger power system power requirement very low, unit on low float voltage to prolong battery life.
- 9) Fast charge unit on constant current mode.
- 10) OK, unit operating within normal parameters
- 11) Fault, fatal fault, needs to be returned for repair.
- 12) Battery type selector, shows which battery charger curve in operation (adjustable).
- 13) Buttons to select charge options (see later in instructions) also used to switch unit **off** or **on** in conjunction with the setup button (see 14).
Off select button press **down** button for 5 seconds.
On select button press **up** button for 5 seconds.
- 14) Button to enter selections. Also, use to switch unit on/off in conjunction with the up or down button.
- 15) Battery health program, unit doing a 21 day desulphation cycle.
- 16) Absorption, charger on initial charge cycle.
- 17) De-sulphation cycle operational. For safety reasons only available when on **open lead acid** battery type.
- 18) Float, unit on float charge or power pack mode, main charge complete.
- 19) DC output service, output working correctly.
- 20) DC output low voltage warning, either batteries are very low / more power is being taken than the charger can supply / or the charger is defective.
- 21) High voltage trip, the unit is defective and tripped itself, or a high back DC voltage has been detected, like a wind generator reg gone defective.
- 22) High charger temp, if the unit is positioned in too hot an environment and over heated, or the fans have failed.
- 23) Check fans, if LED on, fans are defective.
- 24) Case screws to access the wiring of the product.

	Preset 1 Profiles			x 2 all voltages for 24V unit x 3 for 36V x 4 for 48V			Preset 2 Profiles		
Battery type	High Charge V	Float Charge V	Maintenance V	High Charge V	Float Charge V	Maintenance V	High Charge V	Float Charge V	Maintenance V
Flooded/Open Lead acid	14.8	13.6	12.8	14.7	13.4	12.8	14.7	13.4	12.8
Sealed Lead acid	14.4	13.6	12.8	14.6	13.4	12.8	14.6	13.4	12.8
AGM Lead acid	14.3	13.3	13.0	14.6	13.6	13.0	14.6	13.6	13.0
GEL Lead acid	14.0	13.7	13.2	14.4	13.8	13.2	14.4	13.8	13.2
LiFePO4-Lithium	13.8	13.8	13.2	14.6	14.6	13.2	14.6	14.6	13.2
Calcium / Custom	15.1	13.6	13.2	Your choice see custom setup in instructions					
Equalization / Desulph	15.5	15.5		15.5	15.5				

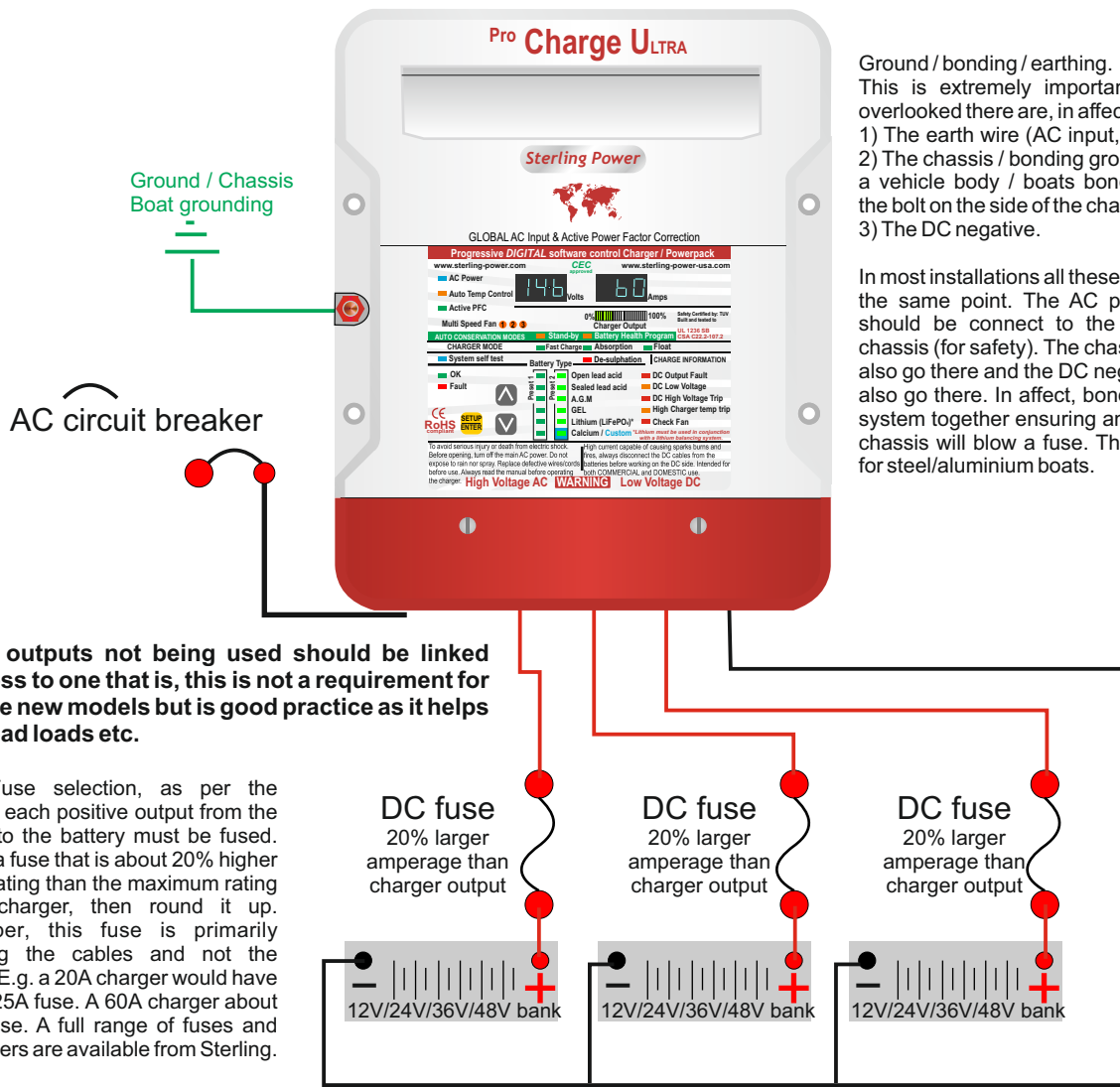

Ground / bonding / earthing.
 This is extremely important and often overlooked there are, in affect, 3 grounds.
 1) The earth wire (AC input, the ground).
 2) The chassis / bonding ground (going to a vehicle body / boats bonding system, the bolt on the side of the charger)
 3) The DC negative.

In most installations all these will end up at the same point. The AC power source should be connect to the boat/vehicle chassis (for safety). The chassis earth will also go there and the DC negative should also go there. In affect, bonding the total system together ensuring any fault to the chassis will blow a fuse. This could vary for steel/aluminium boats.

Any outputs not being used should be linked across to one that is, this is not a requirement for these new models but is good practice as it helps spread loads etc.

DC - Fuse selection, as per the diagram, each positive output from the charger to the battery must be fused. Choose a fuse that is about 20% higher current rating than the maximum rating of the charger, then round it up. Remember, this fuse is primarily protecting the cables and not the product. E.g. a 20A charger would have about a 25A fuse. A 60A charger about a 75A fuse. A full range of fuses and fuse holders are available from Sterling.

AC installation (input to charger)

Wiring, using ring or captive spade connections and a proper crimping tool attach the AC cables Live (line) Neutral and Earth / Ground. Repeat the procedure for the breaker side of the install, support the cable every 18 inches / 0.5 m and protect from sharp edges when passing through bulkheads and all other openings as per any standards which apply to the installation.

Model	Europe AC cable size (mm ²) for cable length up to 15 m		USA AC cable size (AWG) for cable length up to 50ft	
	110 volt	230 volt	110 volt	230 volt
PCU1210	3 core 0.75 mm ² 6 A	3 core 0.75 mm ² 4 A	3 core 16 AWG 6 A	3 core 18 AWG 4 A
PCU1220	3 core 0.75 mm ² 8 A	3 core 0.75 mm ² 6 A	3 core 16 AWG 8 A	3 core 18 AWG 6 A
PCU1230	3 core 1.5 mm ² 11 A	3 core 1.5 mm ² 7 A	3 core 14 AWG 11 A	3 core 16 AWG 7 A
PCU1240	3 core 1.5 mm ² 14 A	3 core 1.5 mm ² 7 A	3 core 14 AWG 14 A	3 core 16 AWG 7 A
PCU1250	3 core 1.5 mm ² 16 A	3 core 1.5 mm ² 8 A	3 core 12 AWG 16 A	3 core 14 AWG 8 A
PCU1260	3 core 1.5 mm ² 16 A	3 core 1.5 mm ² 8 A	3 core 12 AWG 16 A	3 core 14 AWG 8 A
PCU2420	3 core 1.5 mm ² 14 A	3 core 1.5 mm ² 7 A	3 core 14 AWG 14 A	3 core 16 AWG 7 A
PCU2430	3 core 1.5 mm ² 16 A	3 core 1.5 mm ² 10 A	3 core 12 AWG 16 A	3 core 12 AWG 8 A
PCU3620	3 core 1.5 mm ² 16 A	3 core 1.5 mm ² 10 A	3 core 12 AWG 16 A	3 core 14 AWG 8 A
PCU4815	3 core 1.5 mm ² 16 A	3 core 1.5 mm ² 10 A	3 core 12 AWG 16 A	3 core 14 AWG 8 A

Model	Europe DC Charge cable size (mm ²) for cable length		USA DC Charge cable size (AWG) for cable length	
	1m	2m	5 ft	10 ft
PCU1210	2.5 mm ²	4 mm ²	16 AWG	14 AWG
PCU1220	4 mm ²	10 mm ²	14 AWG	10 AWG
PCU1230	6 mm ²	6 mm ²	12 AWG	10 AWG
PCU1240	10 mm ²	16 mm ²	10 AWG	8 AWG
PCU1250	10 mm ²	25 mm ²	8 AWG	6 AWG
PCU1260	16 mm ²	25 mm ²	8 AWG	6 AWG
PCU2420	4 mm ²	10 mm ²	14 AWG	10 AWG
PCU2430	6 mm ²	6 mm ²	12 AWG	10 AWG
PCU3620	4 mm ²	10 mm ²	14 AWG	10 AWG
PCU4815	4 mm ²	10 mm ²	16 AWG	14 AWG

DC installation (output from charger)

Choosing cable. unlike AC conductors, DC is very sensitive to voltage drop. The longer the cable runs the larger the cable thickness needs to be. Ensure only quality fire retardant cable is used.

IMPORTANT

The closer to the batteries you fit the charger the better. Not only do you save expensive cable you also get better performance from the charger. The cable should be properly rated to 105 deg C fire resistant. Do not use solid cable or speaker wire.

Model	Europe AC cable size (mm ²) for cable length up to 15 m		USA AC cable size (AWG) for cable length up to 50ft	
	110 volt	230 volt	110 volt	230 volt
PCU1210	3 core 0.75 mm ² 6 A	3 core 0.75 mm ² 4 A	3 core 16 AWG 6 A	3 core 18 AWG 4 A
PCU1220	3 core 0.75 mm ² 8 A	3 core 0.75 mm ² 6 A	3 core 16 AWG 8 A	3 core 18 AWG 6 A
PCU1230	3 core 1.5 mm ² 11 A	3 core 1.5 mm ² 7 A	3 core 14 AWG 11 A	3 core 16 AWG 7 A
PCU1240	3 core 1.5 mm ² 14 A	3 core 1.5 mm ² 7 A	3 core 14 AWG 14 A	3 core 16 AWG 7 A
PCU1250	3 core 1.5 mm ² 16 A	3 core 1.5 mm ² 8 A	3 core 12 AWG 16 A	3 core 14 AWG 8 A
PCU1260	3 core 1.5 mm ² 16 A	3 core 1.5 mm ² 8 A	3 core 12 AWG 16 A	3 core 14 AWG 8 A
PCU2420	3 core 1.5 mm ² 14 A	3 core 1.5 mm ² 7 A	3 core 14 AWG 14 A	3 core 16 AWG 7 A
PCU2430	3 core 1.5 mm ² 16 A	3 core 1.5 mm ² 10 A	3 core 12 AWG 16 A	3 core 12 AWG 8 A
PCU3620	3 core 1.5 mm ² 16 A	3 core 1.5 mm ² 10 A	3 core 12 AWG 16 A	3 core 14 AWG 8 A
PCU4815	3 core 1.5 mm ² 16 A	3 core 1.5 mm ² 10 A	3 core 12 AWG 16 A	3 core 14 AWG 8 A

Model	Europe DC Charge cable size (mm ²) for cable length		USA DC Charge cable size (AWG) for cable length	
	1m	2m	5 ft	10 ft
PCU1210	2.5 mm ²	4 mm ²	16 AWG	14 AWG
PCU1220	4 mm ²	10 mm ²	14 AWG	10 AWG
PCU1230	6 mm ²	6 mm ²	12 AWG	10 AWG
PCU1240	10 mm ²	16 mm ²	10 AWG	8 AWG
PCU1250	10 mm ²	25 mm ²	8 AWG	6 AWG
PCU1260	16 mm ²	25 mm ²	8 AWG	6 AWG
PCU2420	4 mm ²	10 mm ²	14 AWG	10 AWG
PCU2430	6 mm ²	6 mm ²	12 AWG	10 AWG
PCU3620	4 mm ²	10 mm ²	14 AWG	10 AWG
PCU4815	4 mm ²	10 mm ²	16 AWG	14 AWG

Remove the 2 screws on the bottom of the front cover marked number 24 on the previous pages quick guide this will reveal the main wiring area.

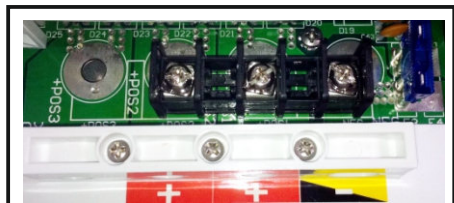

PCU 12V 10A & 20A models have ring terminal screw connectors as depicted above. N.B. the 10A model has only 2 outputs, all other models have 3 outputs.

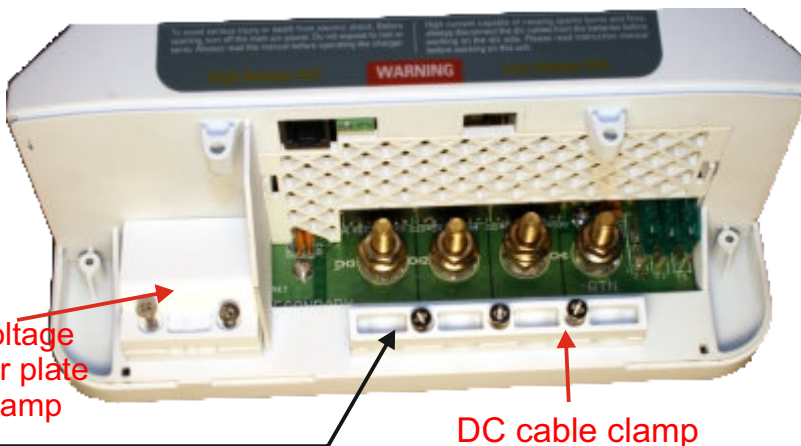

High Voltage AC cover plate and clamp

DC cable clamp

Remove the 2 screws on the AC area and the 3 screws on the DC clamps to enable the appropriate wires to be attached. AC input 80-270V.

Ensure secure connections and correct crimping tools are used.

DC 12V / 24V / 36V / 48V depending on unit.

Remote control

Insert the Sterling remote control into the remote socket (telephone type)

Please note that when the remote is inserted the front program controls on the local panel no longer operate, control is in the remote. Remove the remote to use local controls.

Battery Temperature sensor

Connect the battery temp sensor to the position as shown, connect the sensor end to the negative stud terminal on one of the batteries

which you think will be in the hottest environment.

When the temp. drops the charging voltage goes up incrementally.

When the temp. increases the charging voltage goes down incrementally.

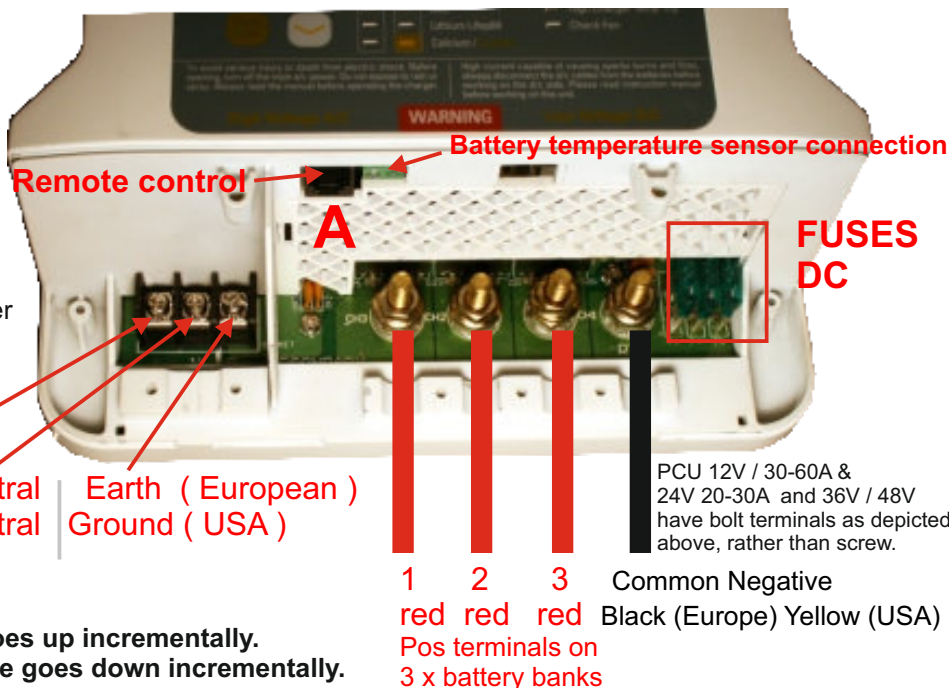

Live | Neutral | Earth (European)
Live | Neutral | Ground (USA)

1 2 3 Common Negative
red red red Black (Europe) Yellow (USA)
Pos terminals on 3 x battery banks

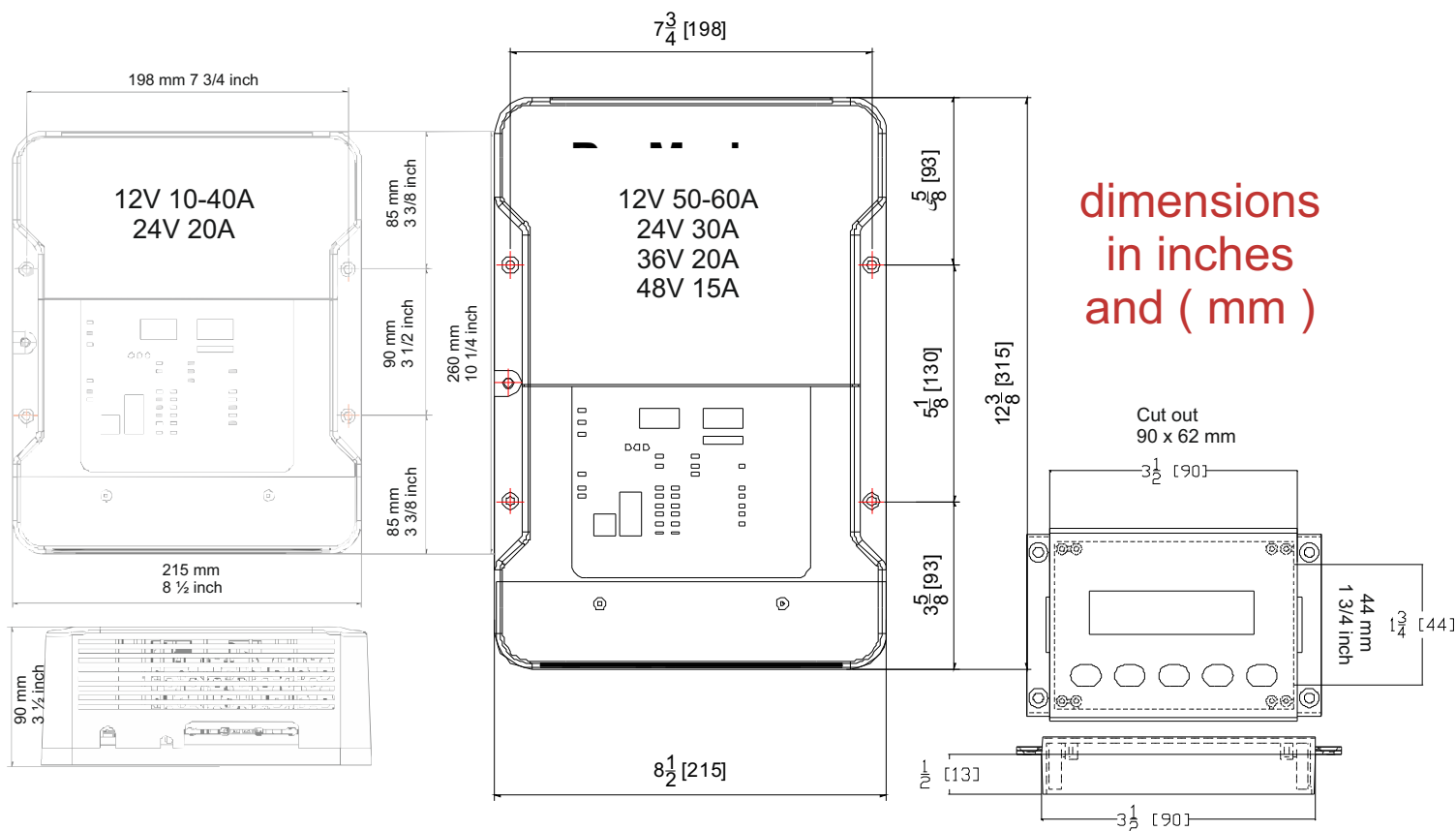

(Optional) Battery Chemistry Module

Multi battery chemistry and voltages output options

Battery Charger Chemistry Modification Module

Another great idea from Sterling. Patent Pending: GB1204145.5

What was the issue which led to the invention of this device?

A lot of new installations on modern boats require different chemistry and even different voltage levels. For instance, you may have a 12V charger but a 24V bow thruster or vice versa. You may also have an open lead acid battery banks and a Lithium. This causes impossible challenges for a standard battery charger or you may simply have one battery bank a long way from another bank requiring very expensive cable runs to prevent voltage drop, (no longer a problem with the BCM).

The solution

The new Sterling Battery Chemistry module has a unique approach to solving this problem. We effectively place in a box a voltage booster and the output stage from a digital charger. This means that the new device can be added to any of the output terminals of our Pro Charge Ultra (or can be used as an add on to most other competitor multiple output charger). This will allow the main 3 (or more) output charger to be set at the lower chemistry voltage for the likes of Gel (14.1V absorption), then, by adding the new Sterling Multi chemistry module to one of the outputs (must be connected to an output of a current limiting charger and cannot be connected direct to a battery). One can adjust that output to a totally different charging chemistry profile. The output voltage and charging curves are independent of the charger's input voltage. This enables a totally different chemistry to be selected. This gives all the advantages of the multi chemistry charger without the huge extra cost, and can be simply retrospectively fitted to any multi output battery charger (within the limitations of the product).

Advantages of this product

- 1) Easy to install.
- 2) Fits our products and most of our competitors multiple output chargers. or converts a single output charger into a multiple output charger.
- 3) 12-12V, 12-24V, 24-24V and 24-12V models.
- 4) 8 selectable independent latest battery chemistries to chose from and a de-sulphation cycle, also LiFePO₄ cycle .
- 5) Battery temperature compensation and high battery temperature trip.
- 6) Remote battery sense compensate for cable voltage drop.
- 7) 6 LEDs projecting over 20 individual charge and warning information events.
- 8) Fail safe, reverts to basic charge function - about 1V less in event of a failure. Product can be replaced / repaired at convenience.
- 9) High battery temperature "daisy chain" trip (optional). This allows every battery to be monitored and the unit can be switched off in the event of battery overheating - causing high battery temperature related problems.
- 10) Ignition fed generator to link in with sterling Pro Split R alternator splitter, this allows the output to be further split.
- 11) Remote control available as an optional extra.

Which model suits my needs. Ensure that your current charger's output is equal to or less than the rating of the product. I.e. a 12V 60A module can be used on any charger up to 12V 60A.

Do you want to simply add a chemistry option. I.e. a different battery type but maintain the same base voltage i.e. 12V or 24V. In which case the BCM1260 will allow a totally separate battery type in the 12V charger.

Do you want a different base voltage and battery type. I.e. you have 12V charger but you want to also charge a 24V battery bank. In this case, go for the BCM 12V-24V option this allows for the different voltage and chemistry

Long cable runs. You may have a very long cable run from the main charger to an important auxiliary battery. Simply add one off these units at the end off the run to boost up the voltage to the required battery type, thus reducing cable thickness requirement and hence cost .

Example - A 12V starter battery bank (sealed lead acid).
A Lithium main battery bank and a 24V open lead acid Bow Thruster.

Battery Chemistry module and optional remote control (remote control not required for operation)

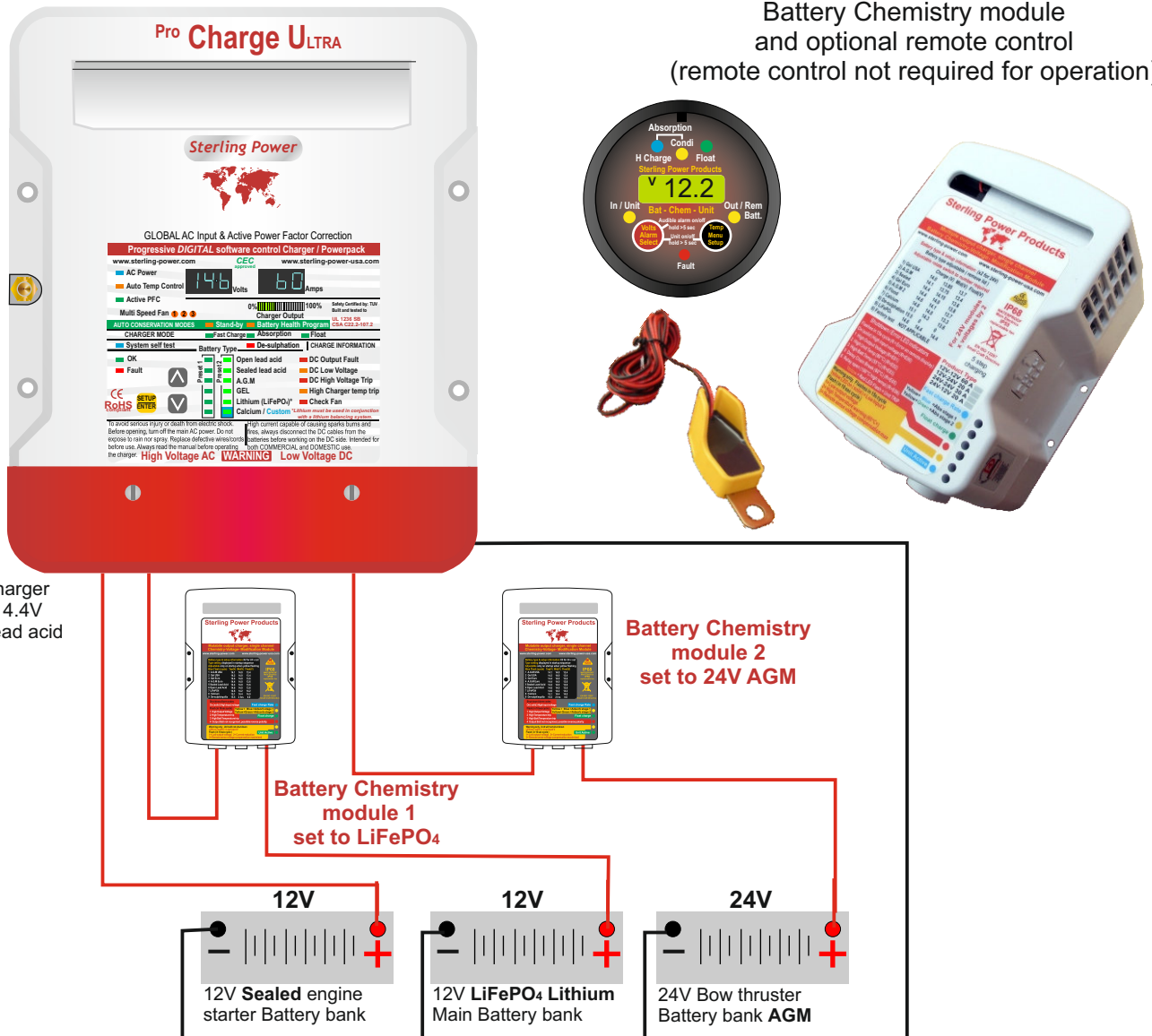

INSTALLATION OF THE BATTERY CHARGER

- Position the charger in a cool, dry and well ventilated space, ensuring a reasonable airflow around the charger. Do not install in a cupboard or sealed compartment.

Charger MUST be installed vertically.

Install as close to the batteries as possible, preferably within 2 meters of the batteries.

To obtain maximum waterproof / ingressproof rating (IP42) mount the charger vertically. However, the unit will work just as well in any fastening orientation so long as it is dry. With regards charging cooling, the unit has thermostatically controlled force draft cooling and is thus able to remain cool whether fastened in any orientation.

Always isolate the AC power before working on it

- Before switching on the charger it is important to set up the battery type. Please choose a battery type from the table (at the bottom of page 2). There are so many different profiles, and battery companies change them all the time. It is impossible to keep up, so in order to assist our customers we offer the option of preset battery types: Flooded, sealed, AGM, Gel, LiFePO₄, calcium and custom. Each type has 2 preset algorithms, for instance: Gel preset 1 is the USA Gel spec (absorption 14.0V and float 13.7V) and Gel preset 2 is the Europe Gel spec (absorption 14.4V and float 13.7V). We also provide the charge voltages related to this cycle. In most cases these are correct; however, if in doubt install on the lower voltage setting until you have checked with your battery supplier.

- In the event of different battery chemistry types. If you are only using the Pro Charge Ultra then the lowest battery voltage type must be selected. Never charge a battery on a higher setting than it should. **If you require different battery chemistries then look at our Battery Chemistry Module (page 5). It allows for different battery chemistry charging.**

If a bespoke battery is being used then use the CUSTOM setting. This gives the user the ability to set their own absorption / float voltages.

- Connect the cables as in the diagram. Ensure that all the terminals are used. In the event of only one battery being charged, connect the surplus positive output to another used output. This ensures correct regulation. Failure to do this will reduce the charging performance.
- IMPORTANT: Always connect the cables to the charger first then run them to the batteries. NEVER connect to the batteries first and then run to the charger.

Pre setup Mode overview CEC mode (bc) and Power Supply mode (PS)

This Pro Charge Ultra is now constructed with the most power efficient technology available for a battery charger providing both charging and maintaining capability. This overall design and efficiency will reduce the overall operating cost of the unit by conserving AC power when it is not needed. Meanwhile, it provides perfect battery maintenance and overall superior DC charging performance. The combination of sophisticated hardware and software includes the detection of the presence of one or more batteries connected to the Pro Charge Ultra. NOTE: If there is no battery connected, the battery charger will not operate in the new default bc mode, however this unit can easily adjusted to the older PS mode which will allow the unit to work in power supply mode. See PS (Power Supply) mode selection below.

Two operational modes. The unit can be used in CEC mode (default), or PS mode (needs set)

CEC mode. This is a new ecological regulation brought on by the Californian Energy Commission (CEC). It is being adopted by more and more states, we feel that it is such a reasonable regulation that it will eventually be adopted world wide. Essentially, at present, when you charge your phone and your batteries are full then the charger continues to operate. This charger uses a small amount of power simply doing nothing. If you multiply this by millions of households all doing the same thing there is a lot of wasted energy. So, by turning off the charger you could potentially save numerous power stations. It's a lot more complex for a marine battery charger which has to charge the batteries then run the boat as well. However, we have devised a complex algorithm to monitor the power consumption and when it drops below a certain amount we switch off the charger and transfer the monitoring to a very low power operational circuit. If, or when, the battery voltage drops a little our monitoring circuit would recognise this and re-engage the unit. This will maintain the batteries at a full state and operate as a power pack. If unit is "fired up" with no batteries connected the charger will read 0.0 0.0 on the front panel. You must have batteries connected for the unit to activate, if this is not the setting you want then simply set to Power supply mode (see below).

PS mode (power supply). is the way all our chargers have been working up to date, it means the unit will work even if not connected to a battery bank.

What difference will this make ?

- 1) It is now legal in California and other adopted states. The CEC mode future proofs.
- 2) If you power for your system is monitored a reduction in the power used for the equipment should be noticed (you can tell your daughter your now green).

The bottom line as a user on a day to day operation on 99% off installations it will not be a noticeable feature, it would only prove to be a problem if you want to use the charger as a power pack. I.e. not connected to the battery banks. In which case, change the mode.

In the event you would like to use your Pro Charge Ultra as a power supply without a battery in the system you may do so simply by selecting the Power Supply (PS) mode during the initial startup phase. This mode will allow the charger to be used as a power pack for 12V or 24V (model specific).

Selecting PS (Power Supply) Mode Operation During AC Power On Startup overview

When AC power is applied or when the Self Test function is initiated the numerical displays will first display "888" to indicate all segments of the displays are working. Then the display will indicate either "bc" (Battery Charger) or "PS" (Power Supply) for 7 seconds. You can change the required settings during this time frame if required (see below for instructions).

After 7 Seconds the battery charger will default to its "bc" (Battery Charger) mode of operation or the previously programmed function.

Note: The battery charger will default to the Sealed Battery Type Charge profile (for both "bc" and "PS" modes of operation). You may also select any of the other battery type profiles in this mode. See Selecting Battery Type in the programming section of this manual.

If during the AC Power start-up you would like to select the "PS" (Power Supply) mode of operation you may do so during the 7 seconds window while the display is indicating "bc" by:

- 1) Push either the  or  key to toggle between "bc" and "PS"

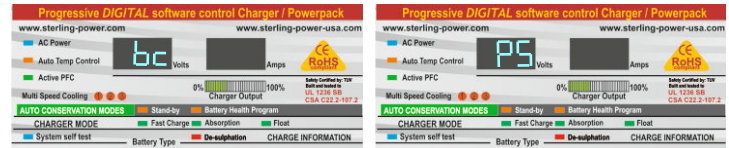

- 2) While the display reads "PS" press Setup/Enter 





Operating Instructions

From main charge only (not remote control)

On/off the unit can be switched off using the controls on the charger main control panel (it can also be switched on/off on the remote (see later))

Unit On press setup and the up button, hold for 5 sec.  

Unit Off press setup / enter and down for 5 sec.  

The blue AC power LED will flash to show the power is available but the unit is not activated.

SELECTING BATTERY TYPE

To select a battery type/charging profile perform the following:

1. Press and hold the "Setup / Enter" button for 6 seconds, then release the button.
2. The current battery type and Voltage / Amperage displays will flash. The voltmeter and ammeter will now display voltage, the left hand screen (marked voltmeter) will show the high charge voltage setting (absorption) and the right hand screen (marked ammeter) will show the low charge / float / power pack voltage setting.
3. Use the "↑" and "↓" keys to scroll through all the different battery types. The LED display on the charger in the battery type section will move through the different types.
4. The voltage and amp readout will display the absorption/conditioning and float voltages for each profile highlighted.
5. Press the "Setup / Enter" button to confirm selection, the LED will remain solid or leave for 30 seconds and the selection will be locked in automatically.

ADJUSTING THE CUSTOM BATTERY TYPE SELECTION

WARNING: *Damage can result to your batteries from improper use of this custom setting. Any damage experienced while using this setting is the responsibility of the user and not covered by any Sterling warranty. ALWAYS consult the battery manufacturer if you are unsure of the battery chemistry and charge profile required.

1. Follow above steps and select the "Custom" option on the battery type display and press enter to enter it.
2. The "Fast charge & Absorption" LEDs will be blinking, indicating you are in the adjustment mode.
3. The left hand meter will blink and the right hand meter will go out. The numbers on the left hand meter will be the high voltage setting. Adjust as required by using the "↑" and "↓" to select voltages up to 15.1V. Press enter when you have selected the correct voltage. Then right hand screen will flash now flash - this is the float voltage settings, again, use the arrows to set this voltage and press enter to finish.

NOTE: During this process, real-time voltage and amperages will not be displayed.

SELF TEST MODE

1. Press and hold the "Setup / Enter" and the "↑" and "↓" buttons simultaneously for 10 seconds then release.
2. The "Self Test" LED will flash until the test is complete.
3. OK or Fault LED's will be displayed, see the Troubleshooting section if the Fault LED is illuminated.



FACTORY RESET



To return the unit to original factory settings (Sealed Lead Acid)

1. Enter battery type selection as above.
2. Use the "↓" key until you leave the battery type LED panel then the de-sulphation light will flash, continue to the next setting. The 2 x voltmeters will display "FAC" "DEF" for factory default.
4. Press the "Setup/Enter" button to confirm selection, the charger will reboot.

EQUALIZATION / DE SULFATION MODE (can only be activated in open lead acid mode)

This mode is only recommended for open lead acid batteries and will only activate when in open lead acid mode. It can be extremely dangerous to use in other battery types, as it will over charge the battery to "blow" the sulfation off the plates. This process generates more gas than normal and, as such, the battery may need topping up after the process. It is NOT recommended on batteries which cannot be topped up.

- 1) Press and hold the setup key for 5 sec  then use the  or  to select the equalization LED (while on flooded battery setting), when selected the LED will flash.

- 2) Once selected hold both  and  for 3 seconds plus, then release.
- 3) The LED will change from flashing to solid, putting the unit into equalising setting for 240 minutes and remain solid for the full time frame.
- 4) Once complete, the charger will revert back to the previous charger setting.

POWER LEVEL ADJUSTMENT

1. Hold the "↑" and "↓" buttons simultaneously for about 20 seconds.
2. Volts will display "PL" for Power Level, and the amps 100 for 100%
3. Press the "↓" to adjust the amperage display from 100, 75, 50, 25% output.
4. Press the "Setup/Enter" button to confirm selection.

NOTE: If no action is taken after 15 seconds, the unit reverts to 100% power.

Pro Charge Ultra Remote Control

and scroll through to the required information.

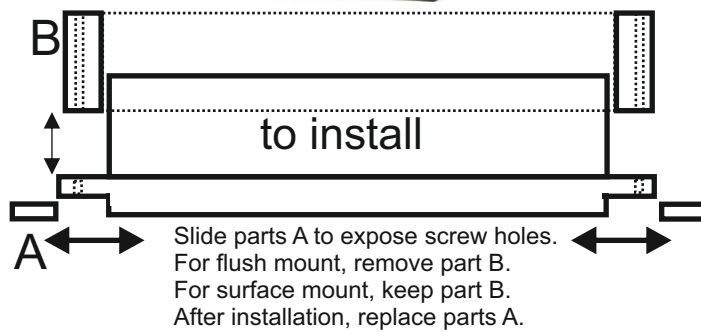

d. Button Functions:

Both the or are used for toggling up and down through the menu options after the Setup/Enter button has been pressed

Additional Charger Modes

FORCE TO READY/FLOAT Maintenance = "Hold" 10 Seconds

The force to float mode is not necessary for standard operation.

1. Hold the button down for 10 seconds.
2. The display will stop scrolling and a "Beep" sound to confirm entered into this mode after button released.
3. The charger will go to float mode and will remain in float until battery voltage drops to a level where Charge is require or until power is recycled.

If you do use this function to get out off it you must switch the charger off at the main AC power source to reset this.

POWER LEVEL ADJUSTMENT = "Hold" 15 Seconds

- I. Hold ""both "" down together for 15 seconds.
- II. The display will stop scrolling and a "Beep" sound to confirm entered into this mode after buttons released.
- III. Press "" to adjust the Amperage display from 100, 75, 50, 25% output.
- IV. Once Power Level is desired confirm the selection by pushing "Setup/Enter".
- V. If no actions are taken in 15 seconds the unit reverts to 100% power.
- VI. Remote will display Power level at % that is selected (100, 75, 50, 25 for one second on, then one second off, then on displaying Voltage and Amperage at that selected power level).
- VII. Once a power reduction is selected it remains permanent until re-programmed again.
- VIII. To re-adjust the power level follow steps 1-5 making sure to confirm 100% to resume normal operation.
- IX. When in power level mode selection display (Power Level 50% and output voltage/ current.

Operation:

Power, Start Up and Language Selection:

- a. If breaker is turned on and charger has AC power the remote is lit with the backlight on.
- b. "Language Select: English" (factory default) will display and flash for 5 second. The operator can select the language during these 5 seconds by pressing the UP or DOWN keys to toggle through all of the available languages (English, German, Spanish, Italian, French) and then press SETUP/ENTER key to confirm.
If no selection is made within these 5 seconds, the default language shall be selected.
(If you wish to change the language at a later date, refer to 'language selection' section below).
- c. Charger mode will displayed (Charge, Conditioning, Ready) along with voltage and amperage until another mode is selected.

Button Operation – with AC power applied to the charger

- a. (Backlight) Button Operation:
 1. Press On-Off for about 1 sec the backlight will turn OFF. Warning If you hold for more than 4 sec the complete charger will switch off
 2. Press On-Off for about 1 sec the backlight will turn back ON.
- b. (Alarm) Button Operation:
 1. Press Alarm to turn audible alarm OFF.
 2. Press Alarm to turn audible alarm ON.
- c. (Setup / Enter) Button Operation
*** (If not selection is made within 10 seconds charger defaults to prior setting).
 1. Press the Setup/ Enter button once
 2. This will now allow you to toggle through all available functions using the or

- a. Scrolling – (Must push Setup / Enter to confirm) = will display all of the below one at a time for 4 seconds automatically scrolling through the menu functions.
- b. Charger Name
- c. Charger Status (Same display shows both)
 - i. Mode displaying (Charging, Conditioning or Ready)
 - ii. Output Voltage
 - iii. Output Current
- d. Battery Type Selection (Flooded Preset 1)
- e. Time to Absorption
- f. Run time during this session
- g. Current Set Power Level should be 100% unless in Power Level mode. If a different Power Level is selected the charger will read 100, 75, 50, 25%.
- h. Battery Temperature
- i. Charger Temperature
- j. Transformer Temperature
- k. Faults
 - i. Over Voltage
 - ii. Under voltage
 - iii. Battery Over Temperature
- l. Company Information
- m. Total Run Time
- n. Software Revision

3. Once the remote is displaying the desired function press Setup / Enter button once to show this functions detail. To change selection repeat

SYSTEM SELF TEST MODE = "Hold" 8 Seconds

- I. To test the chargers system hold all three (Setup/ Enter, ,) buttons down for 5 seconds,
- II. The display will stop scrolling and a "Beep" sound to confirm entered into this mode after buttons released.
- III. The charger will "Self Test" and if normal display "System OK" if not a failure or failures will be displayed. If more then one failure exists you can push or to view the failures.
- IV. Press Setup/Enter to go to other functions when complete.

FACTORY RESET = "Hold" 3 Seconds

- I. To restore the Factory Defaults "hold" Alarm, Setup/Enter, and , down for 3 seconds.
- II. The charger will then restart with the factory defaults.

Output ON/OFF function (For Sterling version only)

- a. Press and hold Power button for 4 second to turn the charger output OFF
- b. When charger is OFF, press Power button to turn the charger output ON

How to change language once a language has been selected or defaulted to English

1. Press and hold SETUP/ENTER key for 3 seconds, the display will go to language selection mode.
2. Remote will display the current language and flashing for 5 seconds.
3. Select language within these 5 seconds by pressing UP or DOWN key to toggle through all available language
4. Press SETUP/ENTER key to confirm
5. If no selection is made within these 5 seconds, the language will keep as default or previous setting unchanged.
6. Remote will go back to normal operation
7. The display sequence of language is English, German, Spanish, Italian, French

IMPORTANT SAFETY INSTRUCTIONS

SAVE THESE INSTRUCTIONS - this manual contains important safety instructions for the Pro Charge Ultra

- 1) Do not expose this unit to rain or snow.
- 2) Use of attachments not recommended or sold by Sterling Power will void warranty and may result in the risk of fire.

SHOCK OR PERSONAL INJURY.

- 3) Do not operate the unit if it has been dropped or visibly damaged in any way
- 4) Do not disassemble the unit. If service or repair is required please contact Sterling at:

- 5) To reduce the risk of electrical shock, remove connection to AC shore / station power and DC connections prior to maintenance or cleaning.
 - 6) Turning off controls WILL NOT reduce this risk.
 - 7) Use of extension cord should not be used unless absolutely necessary. If an extension cord must be used, make sure:
 - a) That pins on plug of extension cord are the same number, size and shape of those of the plug on the charger.
 - b) That the extension cord is properly wired and in good electrical condition.
 - c) That wire size is large enough for AC ampere rating of charger as specified in table (page 3)
 - 8) Do not operate charger with damaged cord or plug - replace the cord or plug immediately.
 - 9) Do not operate charger if it has received a sharp blow, been dropped, or otherwise damaged in any way; take it to a qualified serviceman.
 - 10) Do not disassemble charger; take it to a qualified serviceman when service or repair is required.
 - 11) To reduce risk of electric shock, unplug charger from outlet before attempting any maintenance or cleaning. Turning off controls will not reduce this risk.
- WARNING – RISK OF EXPLOSIVE GASES.**
WORKING IN THE VICINITY OF A LEAD-ACID BATTERY IS DANGEROUS. BATTERIES GENERATE EXPLOSIVE HYDROGEN GAS DURING NORMAL BATTERY OPERATION. FOR THIS REASON IT IS OF UTMOST IMPORTANCE THAT EACH TIME BEFORE USING YOUR CHARGER YOU READ THIS MANUAL AND FOLLOW THE INSTRUCTIONS EXACTLY.

To reduce the risk of a battery explosion, follow these instructions and those published by the battery manufacturer and any equipment you intend to use in the vicinity of the battery(s). Carefully review the cautionary markings on this equipment.

SPARK – Be very cautious about dropping metal objects such as screwdrivers and wrenches onto a battery. This could short-circuit the battery and immediately cause a spark that may result in a fire or explosion.

REMOVE – All personal metal items such as rings, watches, bracelets, etc. when working near a battery. A battery can produce a short circuit current high enough to weld a ring or any other metal causing serious burns.

DRY CELL BATTERIES – Never use the battery charger feature to charge dry cell batteries that are commonly used with home appliances i.e. a cordless power drill battery. These batteries may burst and cause injury to persons and damage property.

FROZEN BATTERY – Never charge a frozen battery.

UNPACKING AND INSPECTION – Thoroughly inspect your unit.

11. PERSONAL PRECAUTIONS

- a) Consider having someone close enough by to come to your aid when you work near a lead-acid battery.
- b) Have plenty of fresh water and soap nearby in case battery acid contacts skin, clothing, or eyes.
- c) Wear complete eye protection and clothing. Avoid touching eyes while working near batteries.
- d) If battery acid contacts skin or clothing, wash immediately with soap and water. If acid enters eye, immediately flood eye with running cold water for at least 10 minutes and get medical attention immediately.
- e) NEVER smoke or allow a spark nor flame in vicinity of battery or engine.
- f) Be extra cautious to reduce risk of dropping a metal tool onto battery. It might spark or short-circuit battery or other electrical parts that may cause explosion.
- g) Remove personal metal items such as rings, bracelets, necklaces, and watches when working with lead-acid battery. A lead-acid battery can produce a short-circuit high enough to weld a ring or the like to metal, causing a severe burn.
- h) Use charger for charging a LEAD-ACID battery only. It is not intended to supply power to a low voltage electrical system other than in a starter-motor application. Do not use battery charger for charging dry-cell batteries that are commonly used with home appliances. These batteries may burst and cause injury to persons and damage to property.

GROUNDING AND AC POWER CORD CONNECTION

a) Charger should be grounded to reduce risk of electric shock. Charger is equipped with an electric cord having an equipment-grounding conductor and a grounding plug. The plug must be plugged into an outlet that is properly installed and grounded in accordance with all local codes and ordinances.

DANGER - Never alter AC cord or plug provided - if it will not fit outlet, have proper outlet installed by a qualified electrician. Improper connection can result in a risk of an electric shock.

b) For grounded, cord-connected battery chargers with an input rating less than 15A and intended for use with a global AC input (90V - 270V). This battery charger is for use with a global AC input (90V - 270V) and has a grounding plug. A temporary adaptor, as shown (figure is overleaf), may be used to connect this plug to a two-pole receptacle, if a properly grounded outlet is not available. The temporary adaptor should be used only until a properly grounded outlet can be installed by a qualified electrician.

DANGER - Before using adaptor as illustrated, be certain that center screw of outlet cover plate screw with a longer screw that will secure adaptor ear or lug to outlet cover plate and make ground connection to grounded outlet.

c) For all other grounded, cord-connected battery chargers: This battery charger is for use on a circuit having a nominal rating more than

12. PREPARING TO CHARGE

- a) if necessary to remove battery from vehicle to charge, always remove grounded terminal from battery first. Make sure all accessories in vehicle are off, so as not to cause an arc.
- b) Be sure area around battery is well ventilated while battery is being charged.
- c) Clean battery terminals. Be careful to keep corrosion from coming in contact with eyes.
- d) Add distilled water in each cell until battery acid reaches level specified by battery manufacturer. Do not overfill. For a battery without removable cell caps, such as valve regulated lead acid batteries, carefully follow manufacturer's recharging instructions.
- e) Study all battery manufacturer's specific precautions while charging and recommended rates of charge.
- f) Determine voltage of battery by referring to battery manufacturer's owner's manual and make sure that output voltage selector switch is set at correct voltage. If charger has adjustable charge rate, charge battery initially at lowest rate.

13. CHARGER LOCATION

- a) Locate charger as far away from battery as DC cables permit.
- b) Never place charge directly above battery being charged from battery will corrode and damage charger.
- c) Never allow battery acid to drip on charger when reading electrolyte specific gravity or filling battery.
- d) Do not operate charger in a closed-in area or restrict ventilation in any way.
- e) Do not set a battery on top of charger.

14. DC CONNECTION PRECAUTION

a) Connect and disconnect DC output clips only after setting any charger switches to "OFF" position and removing AC cord from electric outlet. Never allow clips to touch each other.

15. FOLLOW THESE STEPS WHEN BATTERY IS INSTALLED IN VEHICLE/BOAT. A SPARK NEAR BATTERY MAY CAUSE BATTERY EXPLOSION. TO REDUCE RISK OF A SPARK NEAR BATTERY:

- a) Position AC and DC cords to reduce risk of damage
- b) Stay clear of fan blades, belts, pulleys, and other parts that can cause injury to persons.
- c) Check polarity of battery posts. POSITIVE (POS, P, +) battery post usually has larger diameter than NEGATIVE (NEG, N, -) post.
- d) Determine which post of the battery is grounded
- e) For negative-grounded, connect POSITIVE (RED) clip from battery charger to POSITIVE (POS, P, +) ungrounded post of battery. Connect NEGATIVE (BLACK) clip to vehicle chassis or engine block away from battery. Do not connect clip to carburetor, fuel lines or sheet-metal. Connect to a heavy gauge metal part of the frame or engine block.
- g) When disconnecting charger, turn switches to off, disconnect AC cord, remove clip from vehicle chassis, and then remove clip from vehicle chassis, then remove clip from battery terminal.
- h) See operating instructions for length of charge information.

16. FOLLOW THESE STEPS WHEN BATTERY IS OUTSIDE VEHICLE. A SPARK NEAR THE BATTERY MAY CAUSE BATTERY EXPLOSION. TO REDUCE RISK OF A SPARK NEAR BATTERY:

- a) Check polarity of battery posts. POSITIVE (POS, P, +) battery usually has a larger diameter than the NEGATIVE (NEG, N, -) post.
- b) Attach at least a 24-inch-long 6-gauge (AWG) insulated battery cable to NEGATIVE (NEG, N, -)
- c) Connect POSITIVE (RED) charger clip to POSITIVE (POS, P, +) post of battery.
- d) Position yourself and free end of cable as far away from battery as possible - then connect NEGATIVE (BLACK) CHARGER CLIP to free end of cable
- e) Do not face battery when making final connection.

90V (or This appliance is rated more than 15A and is for use on a circuit having a global AC input (90V - 270V) and is factory fitted with a specific electric cord and plug to permit connection to an acceptable electric circuit. Make sure that the charger is connected to an outlet having the same configuration as the plug. No adapter should be used with this charger.

d) For a permanently connected battery charger: **GROUNDING INSTRUCTIONS** - This battery charger should be connected to a grounded, metal, permanent wiring system; or an equipment-grounding conductor should be run with circuit conductors and connected to equipment-grounding terminals or cable on battery charger. Connections to battery charger provided with a grounding pin:

e) For a direct plug-in battery charger provided with a grounding pin: **CAUTION** - Risk of fire or Electric Shock. Connect battery charger directly to grounding receptacle (three-prong). An adapter should not be used with battery charger.

f) For a direct plug-in battery charger having a tab for semipermanent installation: Use only duplex receptacle having center screw; Secure unit in place by receptacle cover screw; and **CAUTION** and the following or equivalent: Risk of Electric Shock or Fire. Disconnect power to receptacle before installing or removing unit. When removing receptacle-cover screw, cover may fall across plug pins or receptacle may become displaced.

g) For a commercial battery charger that is intended to be permanently installed and un-tampered with, the charger should be installed so that it is not likely to be contacted by people.

DAMAGE – If any parts are missing or damaged, or the unit has been damaged in shipping contact Sterling, do not take it back to the place of purchase as we can offer a faster service.

Grounding Methods

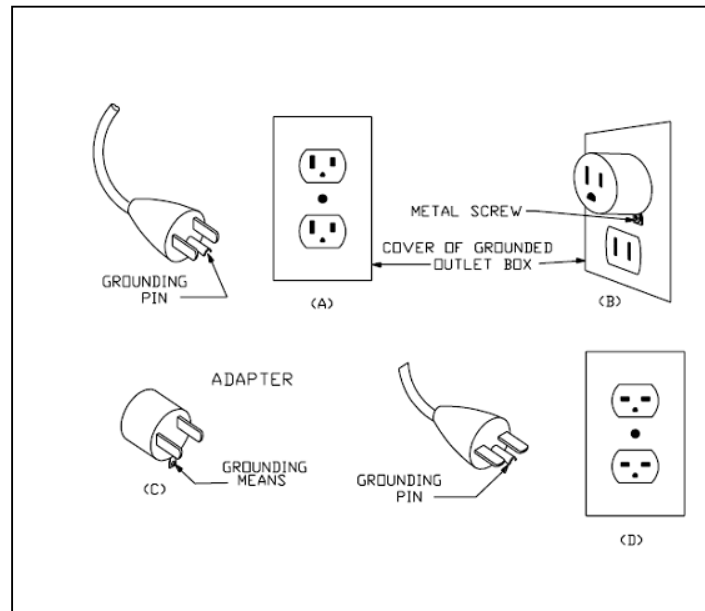

Charger Fault (Service) Conditions		
LED Label	LED Colour	Fault
Reverse Polarity	Red	Indicates a reverse polarity situation
Check DC Connections, ensure positive + (RED) and negative - (Black and / or Yellow) connections are attached accordingly , also check DC fuses,		
DC Volts Low	Amber	DC system V is less than 11V (x2 for 24v)
Wait for battery system voltage to rise over 11.0V and, if not, check and replace defective batteries.		
DC Volts High	Red	Indicates a high DC voltage from an external source such as a failed alternator or wind generator
Using a voltmeter check the voltage at the charger then switch off engine (stop alternator) then other charging sources to establish what is causing the high voltage.		
Charger High Temp	Amber	Charger has shut down due to High temp
Generally this indicates that the unit has been installed in an area of very high ambient temperature. This unit is designed to be used in an engine room up to 45-50 Deg C, the unit will operate in higher ambient temperatures but will reduce its performance off the product, We recommend an ambient off no more than 50 Deg C. The other possibility is that the internal fan may have failed, please listen to ensure the fan is running as one would expect the fan to be on max speed in this fault condition so if quiet this could be the problem		
Check Fan	Red	Fan Failure
Ensure that the cooling fan can move freely and that no debris is blocking the fan movement, the fan should come on during the start up sequence to prove it works, any persistent fan problems may require servicing.		
Fault	Red	Indicates a fault
Possible internal DC fuse blown, Please contact Sterling for service options.		
Auto Temp Control	Red Flash	High Ambient causing power reduction to sustain output.
See charger high temperature above.		

MAINTENANCE

This unit is solid state software controlled and requires no constant adjustments or attention, however, the following items should be checked:

- 1) On start up ensure the panel shows no fault LEDs.
- 2) On start up check the conditions of the fuses and ensure there is no discoloration or corrosion round the fuse, also, check that the breaker will manually trip and reset.
- 3) On start up check the fans cooling flow is not impeded by debris, keep the area round the unit clear of items and dirt.
- 4) On Start up check for any traces of water / other liquids running down the front of the unit or any evidence of this (water stains).
- 5) Do not use the charger, find the leak and fix the leak or remount the charger to a safer place away from the water source.
- 6) Check the battery charger terminals and the battery terminals for corrosion monthly, clean as required.
- 7) As per battery manufacturers' instructions check and top up the batteries with distilled water, as required monthly. Do not use tap or bottled water as this will destroy the batteries.
- 8) Check the wires for any burning or chaffing, monthly. This is where the wires pass through bulkheads. Repair / replace as required.
- 9) When the charger is on, feel the temperature of the batteries, they should not be noticeably hotter than the surrounding ambient temperature. If the batteries are hot to the touch then they need major investigation, check the charger voltage is within parameters. If it is then the battery must be checked as they are probably defective.

Never walk away from warm-hot batteries as there is a major problem, switch the charger off.

The package should contain the following:

- 1) Pro Charge Ultra
- 2) Owners/Installation manual
- 3) Temperature Sensor

DAMAGE – If any parts are missing or damaged, or the unit has been damaged in shipping - contact Sterling. Do not take it back to the place of purchase as we can offer a faster service.

DO NOT attempt to install or operate the unit if it has been damaged in any way.